

## DESCRIPTION

The model L0200 can replace an existing meter head or kept as a spare for those meter locations that cannot have significant downtime.

The meter head bolts to any McCrometer meter that accepts a standard meter head assembly, including models MW500, MW600, MW900, MT900, and MG900.

All Mc Propeller flow meters are manufactured to comply with applicable provisions of AWWA Standard No. C704-02 for propeller-type flow meters.

## FEATURES

### Impellers

- Impellers are manufactured of high-impact plastic, capable of retaining their shape and accuracy over the life of the meter.
- Each impeller is individually calibrated at the factory to accommodate the use of any standard McCrometer register, and since no change gears are used, the meter can be field-serviced without the need for factory recalibration.

### Bearings

- Factory lubricated stainless steel bearings are used to support the impeller shaft.
- The shielded bearing design limits the entry of materials and fluids into the bearing chamber, providing maximum bearing protection.

### Register

- The instantaneous flowrate indicator is standard and available in gallons per minute, cubic feet per second, liters per second and other engineering units.
- The register is driven by a flexible steel cable with a magnetically coupled drive, encased within a protective vinyl liner.

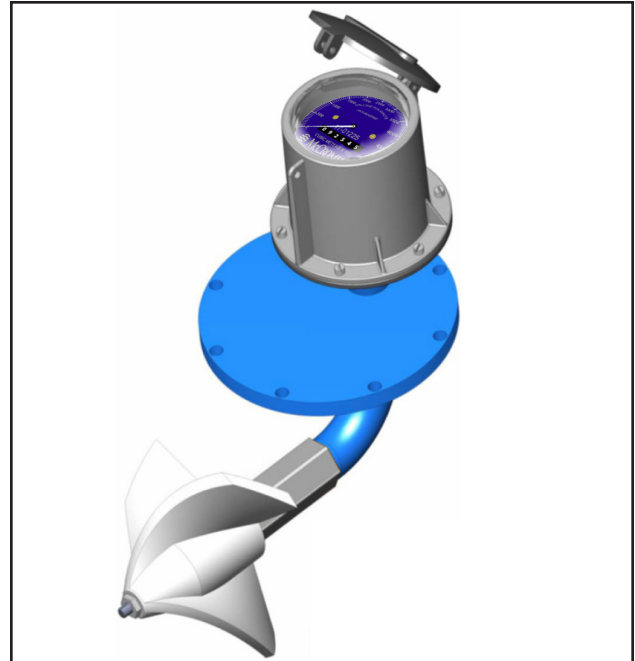

## Typical Applications

The Mc propeller meter is the most widely used flowmeter for municipal and wastewater treatment applications as well as agricultural and turf irrigation measurement. Typical applications include:

- Water and wastewater management
- Center pivot systems
- Sprinkler irrigation systems
- Drip irrigation systems
- Golf course and park water management
- Gravity turnouts for underground pipelines
- Commercial nurseries

- The register housing protects both the register and cable drive system from moisture while allowing clear reading of the flowrate indicator and totalizer.

### INSTALLATION

Standard installation is horizontal mount. If the meter is to be mounted in the vertical position, please advise the factory.

### SPECIFICATIONS

Performance	
<b>Accuracy / Repeatability</b>	<ul style="list-style-type: none"> <li>• <math>\pm 2\%</math> of reading guaranteed throughout full range</li> <li>• <math>\pm 1\%</math> over reduced range</li> <li>• Repeatability 0.25% or better</li> </ul>
<b>Range</b>	See dimensions chart below.
<b>Head Loss</b>	See dimensions chart below.
<b>Maximum Temperature</b>	(Standard Construction) 160°F constant
<b>Pressure Rating</b>	150 psi. Consult factory for higher rated version.
<b>Environmental Rating</b>	NEMA 4X
Materials	
<b>Top Plate</b>	Stainless steel (2" to 4") or fusion-bonded epoxy coated carbon steel (6" and larger)
<b>Bearing Assembly</b>	Impeller shaft is 316 stainless steel. Ball bearings are 440C stainless steel
<b>Magnets</b>	(Permanent type) Alnico
<b>Bearing Housing</b>	<ul style="list-style-type: none"> <li>• For models 2" to 16": 304 stainless steel standard, 316 stainless steel optional</li> <li>• For models 18" and larger: Brass standard, 316 stainless steel optional</li> </ul>
<b>Register</b>	An instantaneous flowrate indicator and six-digit straight-reading totalizer are standard. The register is hermetically sealed within a die cast aluminum case. This protective housing includes a domed acrylic lens and hinged lens cover with locking hasp.
<b>Impeller</b>	Impellers are manufactured of high-impact plastic, retaining their shape and accuracy over the life of the meter.
Options	
	<ul style="list-style-type: none"> <li>• Extended warranty</li> <li>• Register extensions</li> <li>• High temperature construction, 180°F max</li> <li>• Marathon bearing assembly for higher than normal flowrates</li> <li>• Digital propeller meter available for model sizes 4" and larger</li> <li>• A complete line of flow recording/control instrumentation</li> <li>• Canopy boot</li> </ul>

### DIMENSIONS

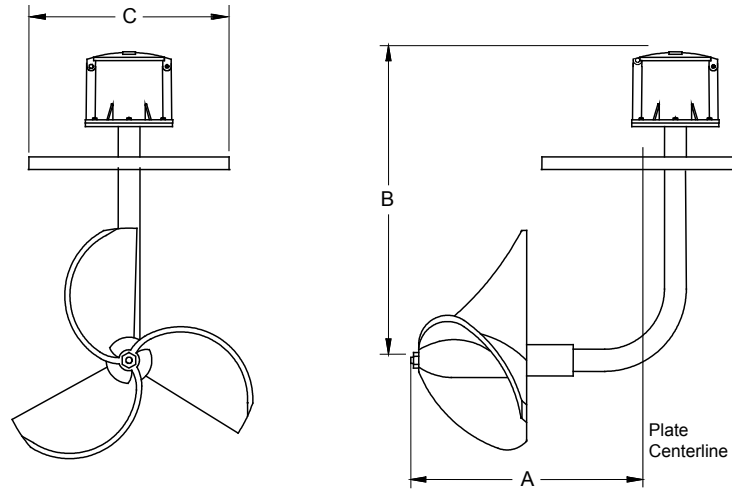

L0200	DIMENSIONS												
Meter Size (inches)	2, 2.5, 3	4	6	8	10	12	14	16	18	20	24	30	36
Part No.	**	L0233-10	L0234-10	L0235-10	L0236-10	L0237-10	L0238-10	L0239-10	L0240-10	L0241-10	L0242-10	L0243-10	L0243-30
Maximum Flow U.S. GPM	250	600	1200	1500	1800	2500	3000	4000	5000	6000	8500	12500	17000
Minimum Flow U.S. GPM	40	50	90	100	125	150	250	275	400	475	700	1200	1500
Approx. Head Loss in psi at Max. Flow	1.06	.83	.61	.24	.14	.1	.07	.06	.05	.05	.04	.03	.02
Approx. Shipping Weight-lbs.	36	30	45	70	90	120	125	130	150	175	190	205	210
A* (inches)	8.5	11.37	12.87	12.87	12.12	12.12	12.12	12.12	15.00	15.00	15.00	15.00	15.00
B (inches)	9.5	10.75	10.75	11.75	13.75	14.75	14.75	16.75	16.75	18.75	20.75	22.38	26.38
C (inches)	4.5	5 ½	7 ½	7 ½	10 ¾	10 ¾	10 ¾	10 ¾	12 ¾	12 ¾	12 ¾	18	20
No. of Top Plate Bolts	6	6	8	8	12	12	12	12	16	16	16	16	16

\*Dimension A is from center of meter head weldment.

\*\*Use L0232-10 for meters built prior to January 1, 2000, and L0232-20 for meters built after January 1, 2000 and beginning with serial #00-7974-XX.

**On ordering, please specify serial number of existing meter head assembly.**

### PIPE RUN REQUIREMENTS

#### Upstream Requirement

Mc Propeller meters should be installed a minimum of five to ten diameters downstream of any obstructions.

#### Downstream Requirement

The downstream run should be one diameter of straight pipe length after the meter.

Configuration	A	B
Without straightening vanes	10	1
With straightening vanes	5	1
With FS100 Flow Straightener	1.5	1

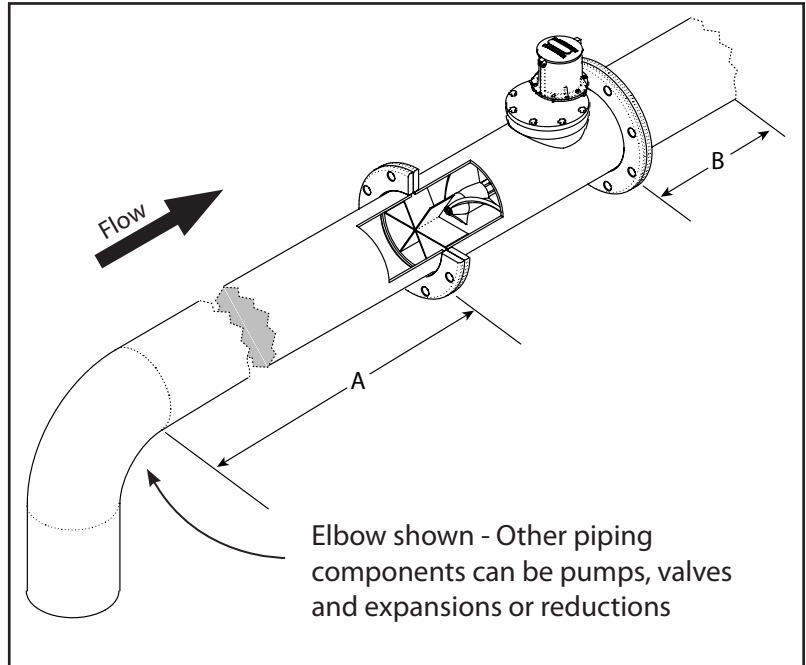

### STRAIGHTENING VANES

Special attention should be given to systems using two elbows “out of plane” or devices such as a centrifugal sand separator. These cause swirling flow in the line that affect propeller meters. Well developed swirls can travel up to 100 diameters downstream if unobstructed. Since most installations have less than 100 diameters to work with, straightening vanes become necessary to alleviate the problem. Straightening vanes will break up most swirls and ensure more accurate measurement. McCrometer actively encourages installing vanes just ahead of the meter. Straightening vanes are available in weld-in, bolt-in, and the FS100 Flow Straightener.

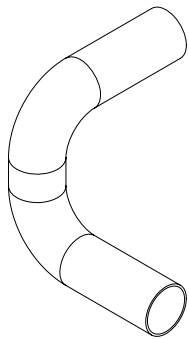

**Elbows out of plane**

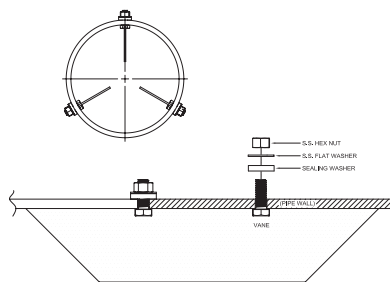

**Bolt-in straightening vanes**

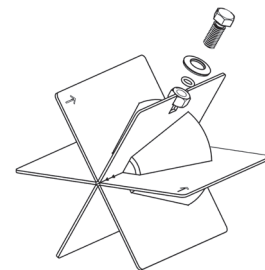

**FS100 Flow Straightener**

### TOTALIZERS

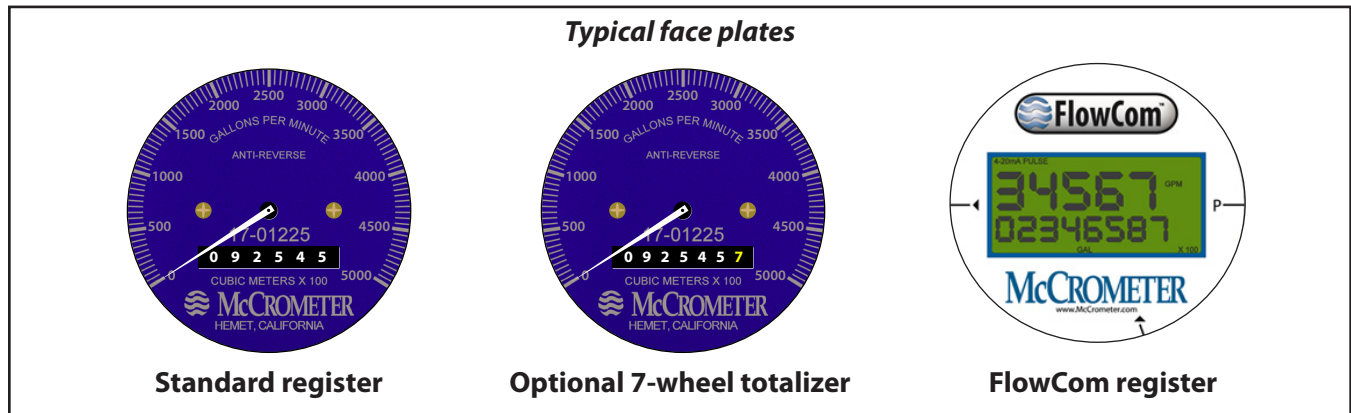

### Mechanical Totalizer

The instantaneous flowrate indicator is standard and available in gallons per minute, cubic feet per second, liters per second and other units. The register is driven by a flexible steel cable encased within a protective vinyl liner. The register housing protects both the register and cable drive system from moisture while allowing clear reading of the flowrate indicator and totalizer.



### Digital Totalizer

The optional FlowCom register displays a flowmeter's flowrate and volumetric total. Available are optional outputs: scaled pulse and/or industry standard 4-20mA signal. The FlowCom can be fitted to any new or existing McCrometer propeller flowmeter.



### Wireless Telemetry

The optional FlowConnect is designed specifically for wireless telemetry via either satellite or cellular data service. Manual meter reading is never required. It uses either the mechanical register or the digital register (both shown above).

You can determine how often readings are made and transmitted to the cloud database, which you can view on a PC or on a cell phone. The viewing utility provides data tools that can analyze flow rate, consumption, and possible anomalies in an irrigation system.

### Accuracy

ACCURACY CHART

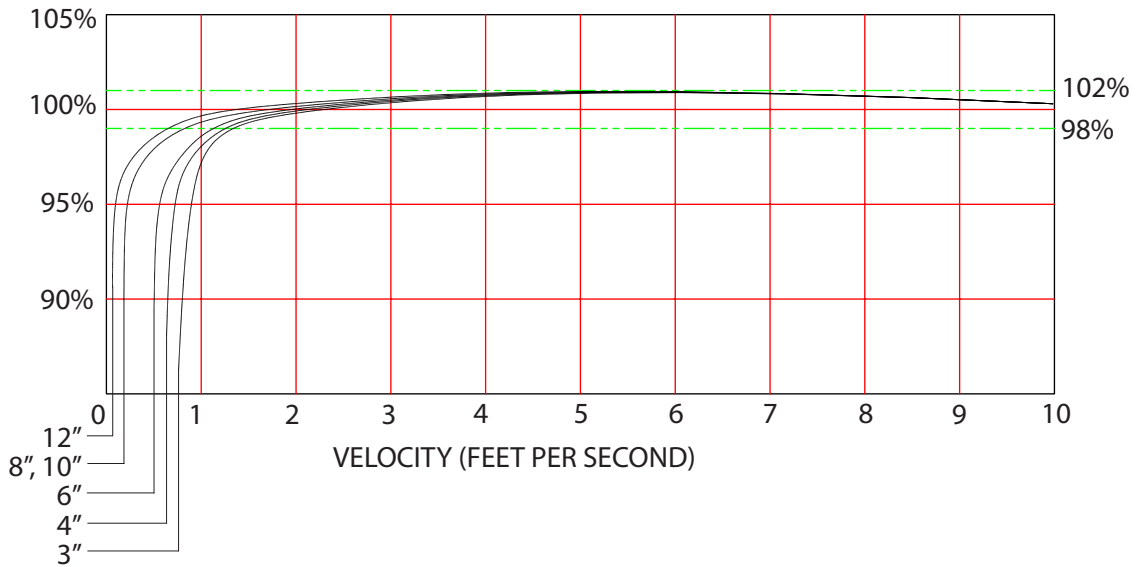

Standard flowrates for McCrometer propeller meters are shown below. Readings are guaranteed accurate within  $\pm 2\%$  in these flowrates. Please note that over 80 percent of the meter's flow range, the accuracy is better than  $\pm 1\%$ .

Nominal Meter Size	2"	2.5"	3"	4"	6"	8"	10"	12"	14"	16"	18"	20"	24"
Minimum Flow(U.S.GPM)	40	40	40	50	90	100	125	150	250	275	400	475	700
Maximum Flow(U.S.GPM)	250	250	250	600	1200	1500	1800	2500	3000	4000	5000	6000	8500
Dial Face Range	250	250	250	800	1300	2500	3000	4000	6000	8000	10000	10000	15000

### Headloss

Headloss refers to the fluid pressure lost due to the meter. Propeller meters have very low permanent headloss as seen in the chart below.

HEADLOSS CHART

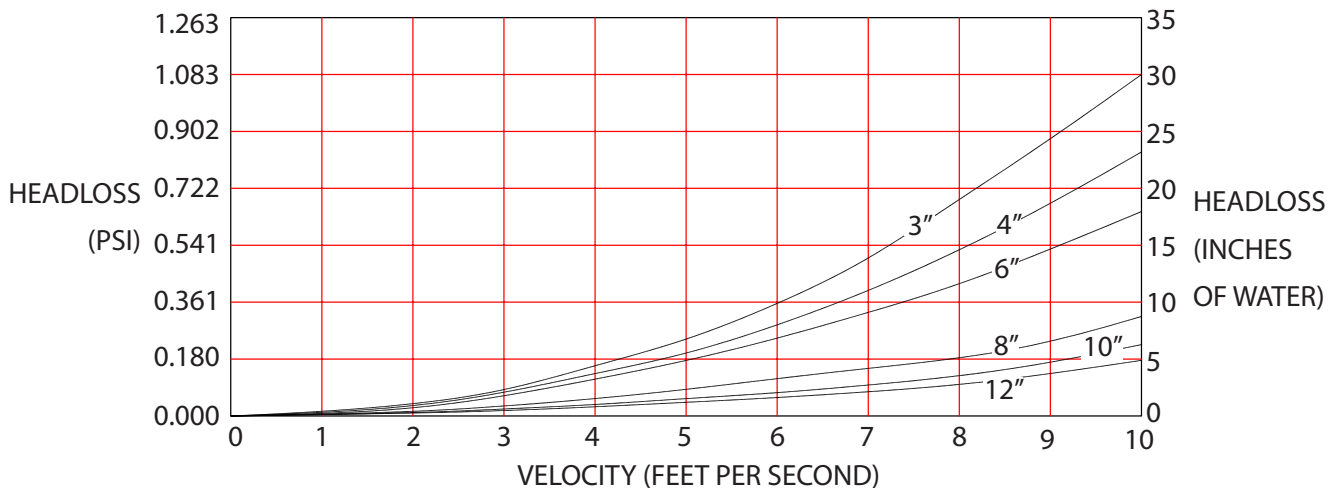

Nominal Meter Size	3"	4"	6"	8"	10"	12"	14"	16"	18"	20"	24"
Max. Headloss (in. H <sub>2</sub> O column)	30	23	17	7	4	3	2	2	2	1	1

Copyright © 2001-2019 McCrometer, Inc. All printed material should not be changed or altered without permission of McCrometer. Any published pricing, technical data, and instructions are subject to change without notice. Contact your McCrometer representative for current pricing, technical data, and instructions.