

## DESCRIPTION

Model MW500 and MZ500 main line propeller flow meters are manufactured to comply with AWWA Standard No. C704-02 for propeller type flowmeters.

- Model MW500 is designed for a maximum continuous working pressure of up to 150 psi and is fitted with AWWA Class D flanges.
- Model MZ500 is designed for a continuous working pressure of up to 300 psi and is fitted with ANSI B16.5 Class 300 flanges.

As with all McCrometer propeller flowmeters, standard features include a magnetically coupled drive, instantaneous flowrate indicator and straight reading, six-digit totalizer. The MW500 and MZ500 can be field-serviced without the need for factory recalibration.

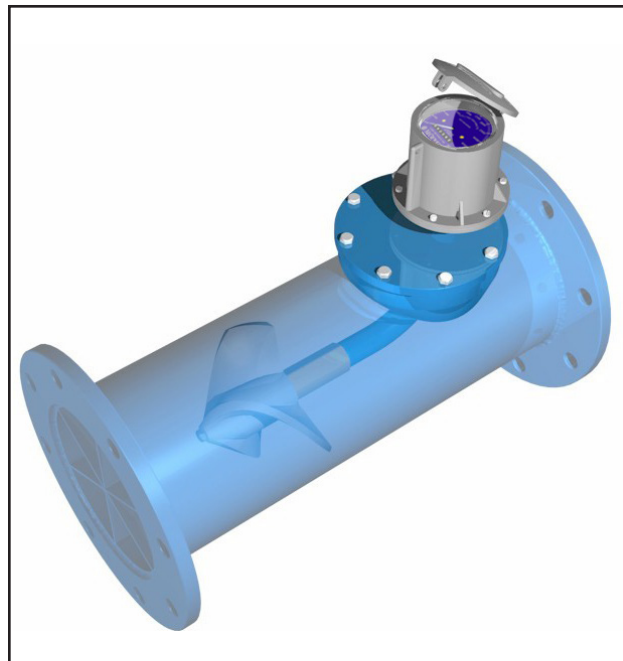

## FEATURES

### Top Plate / Meter Head Weldment

- The meter head weldment is either stainless steel or fusion-bonded epoxy coated carbon steel for maximum corrosion protection.
- The top plate is either stainless steel (for sizes 2" to 4") or fusion-bonded epoxy coated carbon steel (6" and larger).

### Impellers

- Impellers are manufactured of high-impact plastic, capable of retaining their shape and accuracy over the life of the meter.
- Each impeller is individually calibrated at the factory to accommodate the use of any standard McCrometer register.
- The impeller and drive assembly are easily removed through the top flange connection. The meter flow tubes are coated with fusion-bonded epoxy for maximum corrosion protection, and integral flow straightening vanes reduce upstream flow turbulence.

### Bearings

- Factory lubricated stainless steel bearings are used to support the impeller shaft.

## Typical Applications

The McCrometer propeller meter is the most widely used flowmeter for municipal and wastewater treatment applications as well as agricultural and turf irrigation measurement. Typical applications include:

- Water and wastewater management
- Center pivot systems
- Sprinkler irrigation systems
- Drip irrigation systems
- Golf course and park water management
- Gravity turnouts from underground pipelines
- Commercial nurseries

- The shielded bearing design limits the entry of materials and fluids into the bearing chamber providing maximum bearing protection.

### Register

The instantaneous flowrate indicator is standard and available in gallons per minute, cubic feet per second, liters per second and other units. The register is driven by a flexible steel cable encased within a protective vinyl liner. The register housing protects both the register and cable drive system from moisture while allowing clear reading of the flowrate indicator and totalizer.

## INSTALLATION

Standard installation is horizontal mount. If the meter is to be mounted in the vertical position, please advise the factory. A straight run of full pipe the length of five diameters ahead and one diameter behind the meter is the minimum normally recommended.

## SPECIFICATIONS

Performance	
<b>Accuracy / Repeatability</b>	±2% of reading guaranteed throughout full range
<b>Range</b>	See dimensions chart on next page
<b>Head Loss</b>	See dimensions chart on last page
<b>Maximum Temperature</b>	(Standard construction) 160°F constant
<b>Pressure Rating</b>	<ul style="list-style-type: none"> <li>• Model MW500: 150 psi</li> <li>• Model MZ500: 300 psi</li> </ul>
Materials	
<b>Top Plate</b>	Stainless steel (2" to 4") or fusion-bonded epoxy coated carbon steel (6" and larger)
<b>Top Plate Weldment</b>	Stainless steel (2" to 4") or fusion-bonded epoxy coated carbon steel (6" and larger)
<b>Spool</b>	Carbon steel standard, stainless steel optional
<b>Coating</b>	Fusion-bonded epoxy
<b>Body</b>	Epoxy-coated carbon steel pipe conforming to A.S.A pipe schedules
<b>Magnets</b>	(Permanent type) Alnico
<b>Bearing Housing</b>	<ul style="list-style-type: none"> <li>• For models 2" to 16": 304 stainless steel standard, 316 stainless steel optional</li> <li>• For models 18" and larger: Brass standard, 316 stainless steel optional</li> </ul>
<b>Register</b>	An instantaneous flowrate indicator and six-digit straight-reading totalizer are standard. The register is hermetically sealed within a die cast aluminum case. This protective housing includes a domed acrylic lens and hinged lens cover with locking hasp.
<b>Impeller</b>	Impellers are manufactured of high-impact plastic, retaining their shape and accuracy over the life of the meter. High temperature impeller is optional.
Options	
	<ul style="list-style-type: none"> <li>• International flange standards available</li> <li>• Other than standard laying lengths available</li> <li>• Register extensions available</li> <li>• All stainless steel construction</li> <li>• High temperature construction</li> <li>• "Over Run" bearing assembly for higher-than-normal flowrates</li> <li>• Electronic propeller meter available in all sizes of this model</li> <li>• A complete line of flow recording/control instrumentation</li> <li>• Certified calibration test results</li> <li>• Canopy boot</li> </ul>

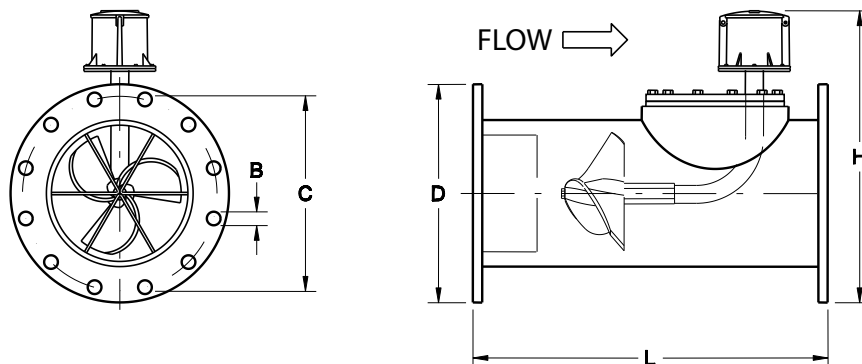
**DIMENSIONS**

MW500/MZ500	DIMENSIONS															
Meter and Nominal Pipe Size	2	2 1/2	3	4	6	8	10	12	14	16	18	20	24	30	36	
Maximum Flow U.S. GPM	250	250	250	600	1200	1500	1800	2500	3000	4000	5000	6000	8500	12,500	17,000	
Minimum Flow U.S. GPM	40	40	40	50	90	100	125	150	250	275	400	475	700	1200	1500	
Approx. Head Loss in Inches at Max. Flow	29.50	29.50	29.50	23.00	17.00	6.75	3.75	2.75	2.00	1.75	1.50	1.25	1.00	1.00	1.00	
<b>MW500</b>																
Approx. Shipping Weight-lbs.	36	36	43	54	115	135	197	325	465	530	744	890	1,293	1450	1650	
B (inches)	3/4	3/4	3/4	3/4	7/8	7/8	1	1	1 1/8	1 1/8	1 1/4	1 1/4	1 3/8	1 3/8	1 5/8	
C (inches)	4 3/4	5 1/2	6	7 1/2	9 1/2	11 3/4	14 1/4	17	18 3/4	21 1/4	22 3/4	25	29 1/2	36	42 3/4	
D (inches)	6	7	7 1/2	9	11	13 1/2	16	19	21	23 1/2	25	27 1/2	32	38 3/4	46	
H (inches)	11 3/4	12 1/4	12 1/2	15 1/4	16 1/4	18 1/2	21 3/4	24 1/4	25 1/4	28 1/2	29 1/4	32 1/2	36 3/4	42 3/4	49 1/4	
L (inches)	14	16	16	20	22	24	26	28	42	48	54	60	60	60	60	
No. of Bolts per Flange	4	4	4	8	8	8	12	12	12	16	16	20	20	28	32	
No. of Topplate Bolts	6	6	6	6	8	8	12	12	12	12	16	16	16	16	16	
<b>MZ500</b>																
Approx. Shipping Weight-lbs.	50	55	62	90	145	220	340	430	650	820	1,315	1,508	2,165			
B (inches)	3/4	7/8	7/8	7/8	7/8	1	1 1/8	1 1/4	1 1/4	1 3/8	1 3/8	1 3/8	1 5/8			
C (inches)	5	5 7/8	6 5/8	7 7/8	10 5/8	13	15 1/4	17 3/4	20 1/4	22 1/2	24 3/4	27	32			
D (inches)	6 1/2	7 1/2	8 1/4	10	12 1/2	15	17 1/2	20 1/2	23	25 1/2	28	30 1/2	36			
H (inches)	12	12 1/2	12 7/8	15 3/4	17	19 1/4	22 1/2	25	26 1/4	29 1/2	32 3/4	34	38 3/4			
L (inches)	20	20	20	24	26	28	30	32	42	48	54	60	60			
No. of Bolts per Flange	8	8	8	8	12	12	16	16	20	20	24	24	24			

Note: Flanges meet ASTM-A-181 specs. Larger flowmeters on special order.

McCROMETER reserves the right to change design or specifications without notice.

### INSTALLATION

Standard installation is horizontal mount. If the meter is to be mounted in the vertical position, please advise the factory. A straight run of full pipe the length of ten pipe diameters upstream and one diameter downstream of the meter is recommended for meters without straightening vanes. Meters with optional straightening vanes require at least five pipe diameters upstream and one diameter downstream of the meter.

### PIPE RUN REQUIREMENTS

#### Upstream Requirement

Mc Propeller meters should be installed a minimum of five to ten diameters downstream of any obstructions.

#### Downstream Requirement

The downstream run should be one diameter of straight pipe length after the meter.

Configuration	A	B
Without straightening vanes	10	1
With straightening vanes	5	1
With FS100 Flow Straightener	1.5	1

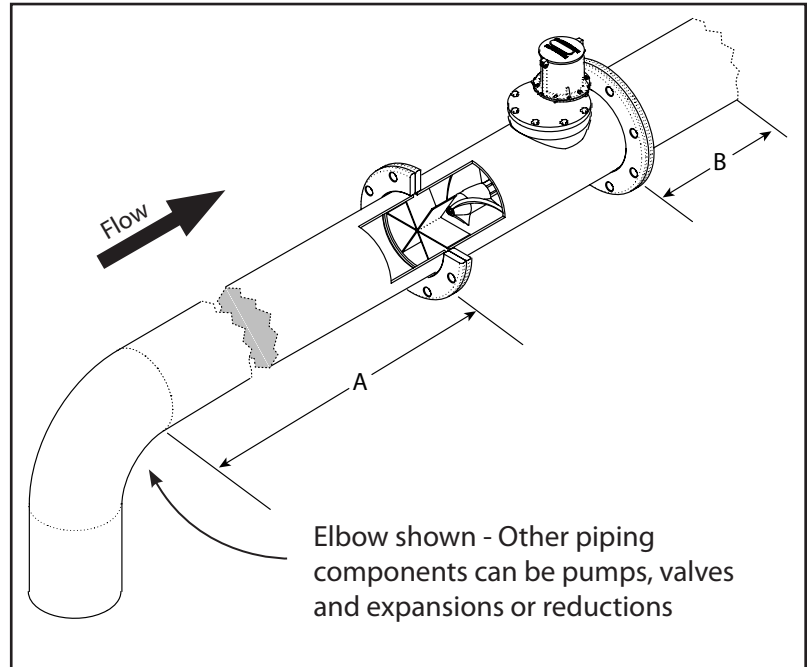

### STRAIGHTENING VANES

Special attention should be given to systems using two elbows “out of plane” or devices such as a centrifugal sand separator. These cause swirling flow in the line that affect propeller meters. Well developed swirls can travel up to 100 diameters downstream if unobstructed. Since most installations have less than 100 diameters to work with, straightening vanes become necessary to alleviate the problem. Straightening vanes will break up most swirls and ensure more accurate measurement. McCrometer actively encourages installing vanes just ahead of the meter. Straightening vanes are available in weld-in, bolt-in, and the FS100 Flow Straightener.

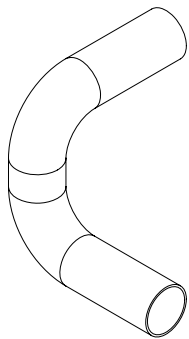

**Elbows out of plane**

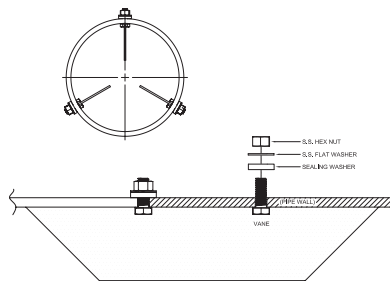

**Bolt-in straightening vanes**

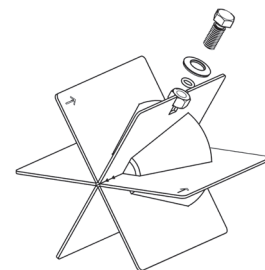

**FS100 Flow Straightener**

**TOTALIZERS**

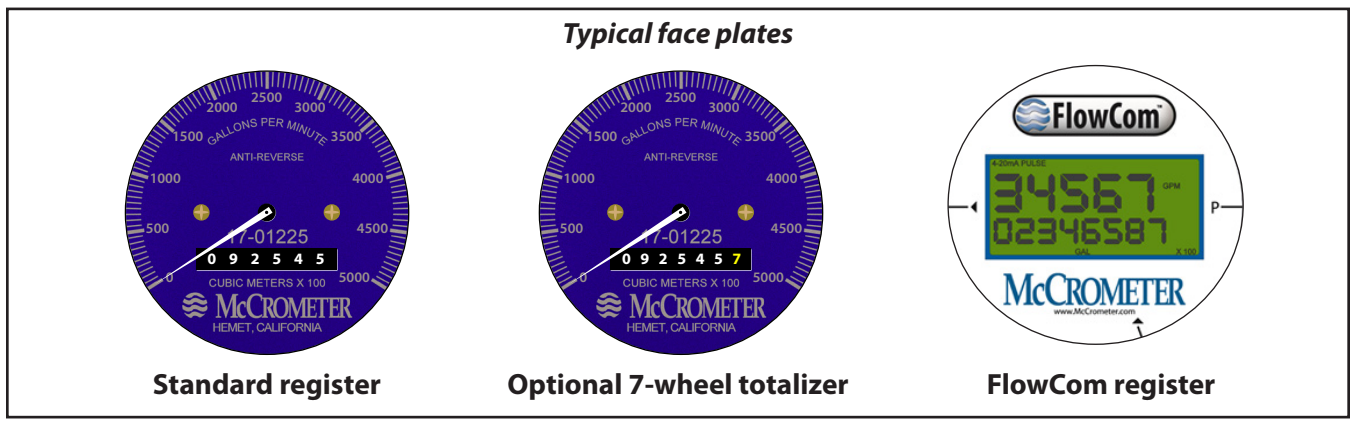

**Mechanical Totalizer**

The instantaneous flowrate indicator is standard and available in gallons per minute, cubic feet per second, liters per second and other units. The register is driven by a flexible steel cable encased within a protective vinyl liner. The register housing protects both the register and cable drive system from moisture while allowing clear reading of the flowrate indicator and totalizer.



**Digital Totalizer**

The optional FlowCom register displays a flowmeter's flowrate and volumetric total. Available are optional outputs: scaled pulse and/or industry standard 4-20mA signal. The FlowCom can be fitted to any new or existing McCrometer propeller flowmeter.



**Wireless Telemetry**

The optional FlowConnect is designed specifically for wireless telemetry via either satellite or cellular data service. Manual meter reading is never required. It uses either the mechanical register or the digital register (both shown above).

You can determine how often readings are made and transmitted to the cloud database, which you can view on a PC or on a cell phone. The viewing utility provides data tools that can analyze flow rate, consumption, and possible anomalies in an irrigation system.

### Accuracy

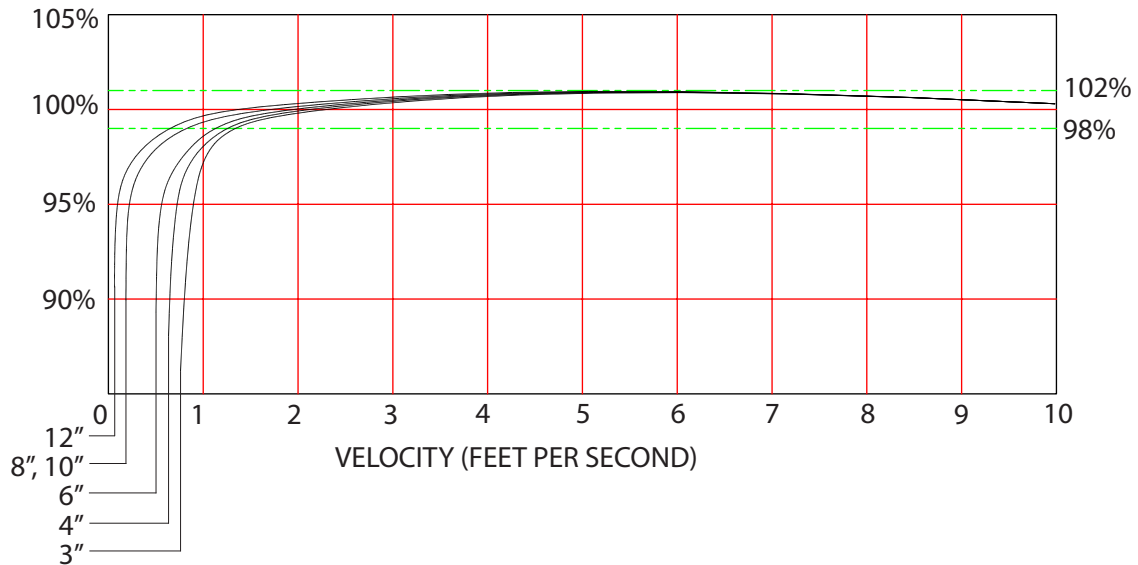
**ACCURACY CHART**

Standard flowrates for McCrometer propeller meters are shown below. Readings are guaranteed accurate within  $\pm 2\%$  in these flowrates. Please note that over 80 percent of the meter's flow range, the accuracy is better than  $\pm 1\%$ .

Nominal Meter Size	2"	2.5"	3"	4"	6"	8"	10"	12"	14"	16"	18"	20"	24"
Minimum Flow(U.S.GPM)	40	40	40	50	90	100	125	150	250	275	400	475	700
Maximum Flow(U.S.GPM)	250	250	250	600	1200	1500	1800	2500	3000	4000	5000	6000	8500
Dial Face Range	250	250	250	800	1300	2500	3000	4000	6000	8000	10000	10000	15000

### Headloss

Headloss refers to the fluid pressure lost due to the meter. Propeller meters have very low permanent headloss as seen in the chart below.

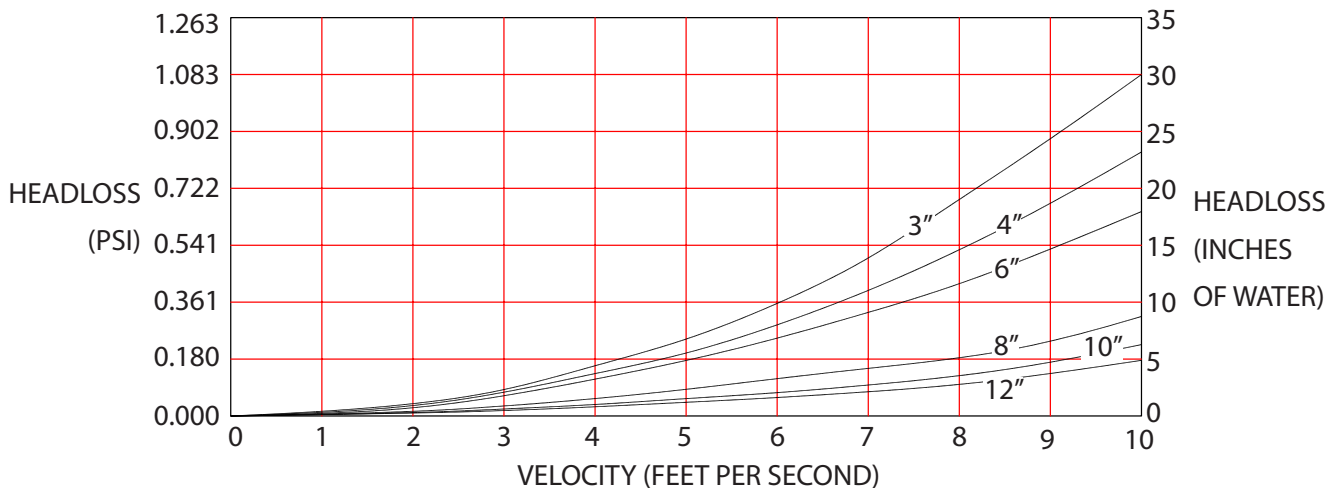
**HEADLOSS CHART**

Nominal Meter Size	3"	4"	6"	8"	10"	12"	14"	16"	18"	20"	24"
Max. Headloss (in. H <sub>2</sub> O column)	30	23	17	7	4	3	2	2	2	1	1

Copyright © 2001-2019 McCrometer, Inc. All printed material should not be changed or altered without permission of McCrometer. Any published pricing, technical data, and instructions are subject to change without notice. Contact your McCrometer representative for current pricing, technical data, and instructions.