



M-SERIES ELECTROMAGNETIC FLOW METER CONVERTER

Installation, Operation and Maintenance Manual

30124-40, Rev. 1.1
February 23, 2018



CE COMPLIANT

Important Information:

Converter Model Number: _____

Converter Serial Number: _____

Meter Serial Number: _____

RETAIN THIS MANUAL - DO NOT DISCARD

Contents

SAFETY.....	1
1.0 M-SERIES CONVERTER OVERVIEW	2
1.1 Serial Numbers.....	3
2.0 CONVERTER INSTALLATION	3
2.1 Mounting The Converter.....	3
2.2 Installing Cables To Converter And Service Loop.....	3
2.3 Pulling Sensor Cable Through Electrical Conduit	4
3.0 ELECTRICAL CABLE CONNECTIONS	5
3.1 Terminal Board.....	5
3.2 FPI Mag 394L Bidirectional Cable Connections	6
3.3 FPI Mag 395L Forward Only Cable Connections	6
3.4 Converter Grounding.....	7
3.5 4-20mA Hook-Up	8
3.6 Opto-Isolated Pulse Output Hook-Up	9
3.7 Opto-Isolated Pulse Input.....	10
3.8 Converter Power Hook-Up	11
4.0 CONVERTER START-UP - ALL SENSORS	12
4.1 Menu Navigation.....	12
4.2 Front Panel Display.....	13
4.3 M-Series Menu Structure	14
4.4 Factory Set Key Code	14
5.0 PROGRAMMING EXAMPLE	15
6.0 MENU 0 - QUICK START	16
7.0 MAIN MENU DESCRIPTIONS.....	20
7.1 Menu 1 - Sensor	20
7.2 Menu 2 - Scales.....	22
7.3 Menu 3 - Measure	24
7.4 Menu 4 - Alarms.....	24
7.5 Menu 5 - Inputs	25
7.6 Menu 6 - Outputs.....	25
7.7 Menu 7 - Communication	27
7.8 Menu 8 - Display	28
7.9 Menu 9 - Data Logger.....	29
7.10 Menu 10 - Diagnostics	29
7.11 Menu 11 - Internal Data.....	31
8.0 ALARM MESSAGES	33
9.0 SPECIFICATIONS	34
10.0 RETURNING A UNIT FOR REPAIR.....	35
11.0 TROUBLESHOOTING GUIDE.....	36
APPENDIX 1.0 UNITS OF MEASURE	37
APPENDIX 2.0 CONVERSION TABLES.....	38
WARRANTY STATEMENT.....	39

SAFETY

Safety Symbols And Warnings

Throughout this manual are safety warning and caution information boxes. Each warning and caution box will be identified by a large symbol indicating the type of information contained in the box. The symbols are explained below:



This symbol indicates important safety information. Failure to follow the instructions can result in serious injury or death.



This symbol indicates important information. Failure to follow the instructions can result in permanent damage to the meter or installation site.

Safety Warnings

When installing, operating, and maintaining McCrometer equipment where hazards may be present, you must protect yourself by wearing Personal Protective Equipment (PPE) and be trained to enter confined spaces. Examples of confined spaces are manholes, pumping stations, pipelines, pits, septic tanks, sewage digesters, vaults, degreasers, storage tanks, boilers, and furnaces.



WARNING!
Incorrect installation or removal of FPI Mag meters can result in serious injury or death. Read the instructions in this manual on the proper procedures carefully.



WARNING!
Never enter a confined space without testing the air at the top, middle, and bottom of the space. The air may be toxic, oxygen deficient, or explosive. Do not trust your senses to determine if the air is safe. You cannot see or smell many toxic gases.



WARNING!
Never enter a confined space without the proper safety equipment. You may need a respirator, gas detector, tripod, lifeline, and other safety equipment.



WARNING!
Never enter a confined space without standby/rescue personnel within earshot. Standby/rescue personnel must know what action to take in case of an emergency.



WARNING!
Pressurized pipes should only be hot tapped, cut, or drilled by qualified personnel. If possible, depressurize and drain the pipe before attempting any installation.



WARNING!
Carefully read all safety warning tags attached to the meter.



At the end of its lifetime, this product shall be disposed of in full compliance with the environmental regulations of the state in which it is located.

M-SERIES CONVERTER OVERVIEW

1.0 M-SERIES CONVERTER OVERVIEW

Read this entire manual prior to installation and/or changing any settings. Retain this manual in your records, DO NOT DISCARD.

The M-Series signal converter is the reporting, input and output control device for the sensor. The converter allows the measurements, functional programming, control of the sensor and data recording to be communicated through the display and inputs & outputs. The M-Series microprocessor-based signal converter has a twelve-point curve-fitting algorithm to improve accuracy, dual 4-20mA analog outputs, an RS485 communication port, an 8-line graphical backlit LCD display with 3-key touch programming, and a rugged enclosure that meets IP67. In addition to a menu-driven self-diagnostic test mode, the converter continually monitors the microprocessor's functionality. The converter will output rate of flow and total volume. The converter also comes standard with password protection and many more features.

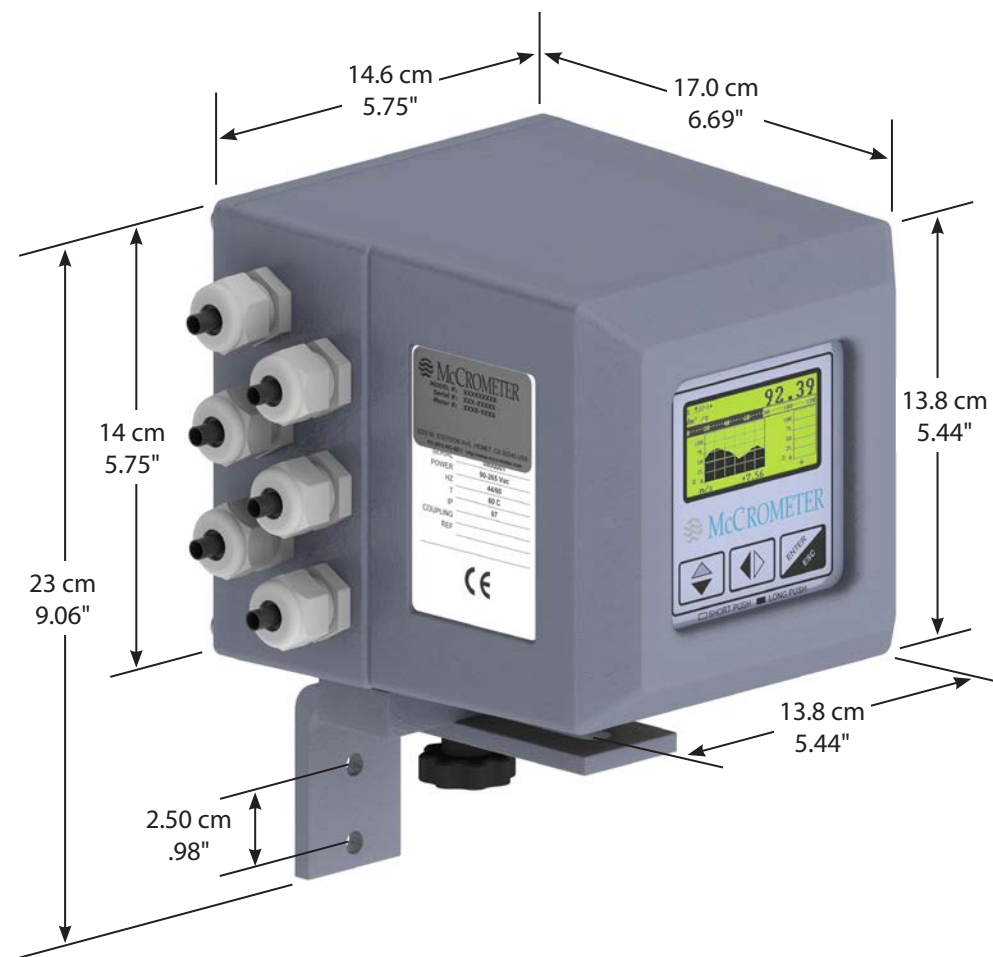

Figure 1. Electronic Converter Dimensions

1.1 Serial Numbers

The converter and sensor are supplied as a matched system. Verify the meter serial numbers on both the converter and sensor match. This will ensure a properly calibrated system.

The tag on the side of the converter has the Converter Model Number, the Converter Serial Number, the Meter Model Number and the Meter Serial Number. An example is show below as Figure 2.

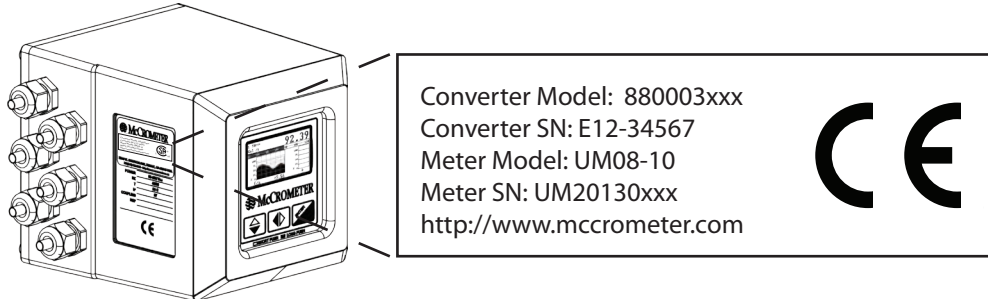

Figure 2. Converter Serial Number Tag



IMPORTANT: Verify the Meter Serial Numbers on both the converter and sensor match. This will ensure a properly calibrated system. The Meter Serial Number is located on the side of the sensor, and the Converter Serial Number and the Meter Serial Number are located on a label on the side of the converter. Ensure the Meter Serial Number on the sensor and the converter tags match.

2.0 CONVERTER INSTALLATION

2.1 Mounting The Converter

If possible mount the converter in an electronics shed or environmental enclosure. If the converter is mounted outdoors a sun shield is recommended. The sun shield should be oriented in a direction to reduce sun damage and ensure readability. The converter is mounted using two bolts (see Figure 1). A service loop in the cables is required (see section 2.2). This electronic unit is rated IP67 for temporary flooding.

2.2 Installing Cables To Converter And Service Loop

Conduit of any kind **CANNOT** be attached directly to the electronics enclosure. Attaching conduit directly to the enclosure will introduce dangerous gasses and moisture into the enclosure creating a dangerous condition, and will remove the enclosure's IP67 rating. **Attaching conduit to the enclosure or altering the enclosure in any way will void the warranty.**

Any cable running through a conduit must exit the conduit and have a minimum of a 20.3 cm (8") service loop before entering the electronics enclosure through the cable glands. All cable compression glands must be properly tightened to prevent moisture intrusion and maintain the IP67 rating. This allows the electronics enclosure to be rotated and the rear panel to be accessed. If electrically bonding (grounding) the enclosure to metallic conduit or raceways, secure a lead wire to the enclosures back panel screw and attach the lead to a listed and approved conduit grounding bushing (see Figure 3). To insure IP67 rating use only round cable 3 mm (0.125") to 9 mm (0.375") in diameter.



IMPORTANT: Do not cut or alter the cable length on power or signal cables!

Connections to the sensor must be made with cable supplied by McCrometer specifically for that purpose. Do not substitute the supplied cable with other types of cable, even for short runs. For repairs or added lengths of cable, the entire cable between the sensor and the converter must be replaced. (Consult factory for replacement cable.)



WARNING: Do not connect any form of conduit directly to the converter enclosure. Doing so will allow moisture and potentially dangerous gasses to enter directly into the converter. Attaching any conduit to the enclosure, or altering the enclosure in any way will void the warranty.

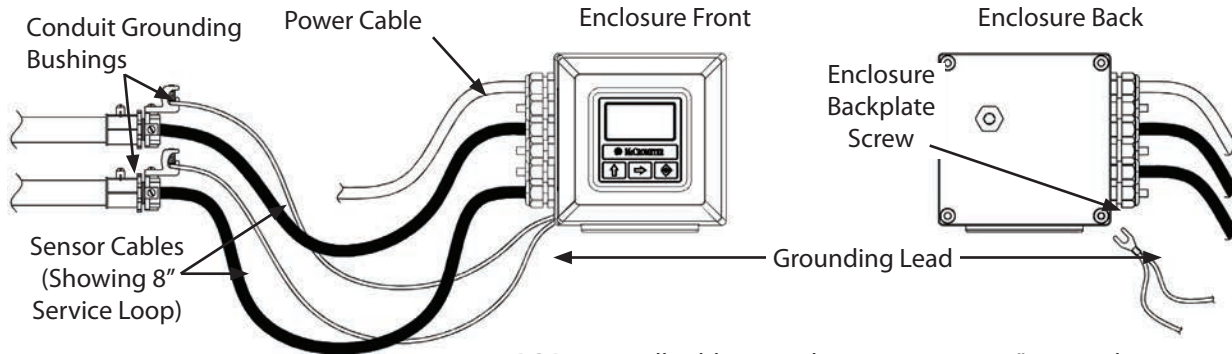

IMPORTANT: All cables must have a minimum 8" service loop.

Figure 3. Cable Installation, A Service Loop And Bonding To Metallic Conduit

2.3 Pulling Sensor Cable Through Electrical Conduit

It is very important to protect the end of the sensor cable when pulling it through a conduit. Water can accumulate in low portions of conduit. Always use the factory supplied cable cover, or similar method, to seal the end of the cable against water when pulling the cable through conduit (see Figure 4). This will ensure proper operation of the meter.

1. Tie a rope or cable-snake securely around the middle of the cable cover.
2. Carefully pull the rope or snake until the sensor cable end clears the conduit.
3. Bring the cable end to the converter location. If necessary, secure the cable so that it does not fall back through the conduit.
4. Remove the cable cover by pulling the rip wire. The cable cover will tear off (discard the cover).



CAUTION: Do not cut the cable cover off. Doing so may damage the sensor cable and adversely effect the calibration of the meter.

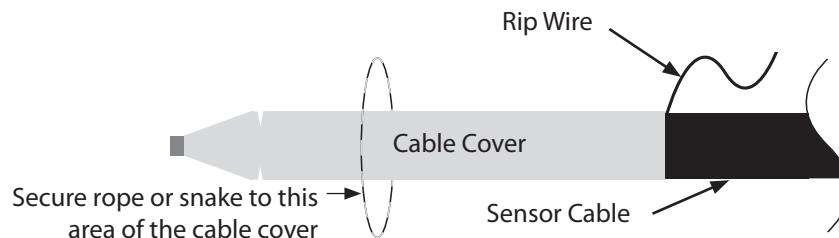

Figure 4. Cable Cover

ELECTRICAL CABLE CONNECTIONS

3.0 ELECTRICAL CABLE CONNECTIONS

All electrical cables enter the converter through compression fittings located on the side of the converter. Ensure that all compression glands are properly tightened and all unused fittings are plugged so the case remains sealed.

CAUTION - Always disconnect the power cord before attempting any electrical connections.

3.1 Terminal Board

All connections are made on the terminal board. To access the terminal board, loosen the four screws on the back of the converter to remove the rear cover.

NOTE: The terminal blocks unplug from the circuit board for easy connection.

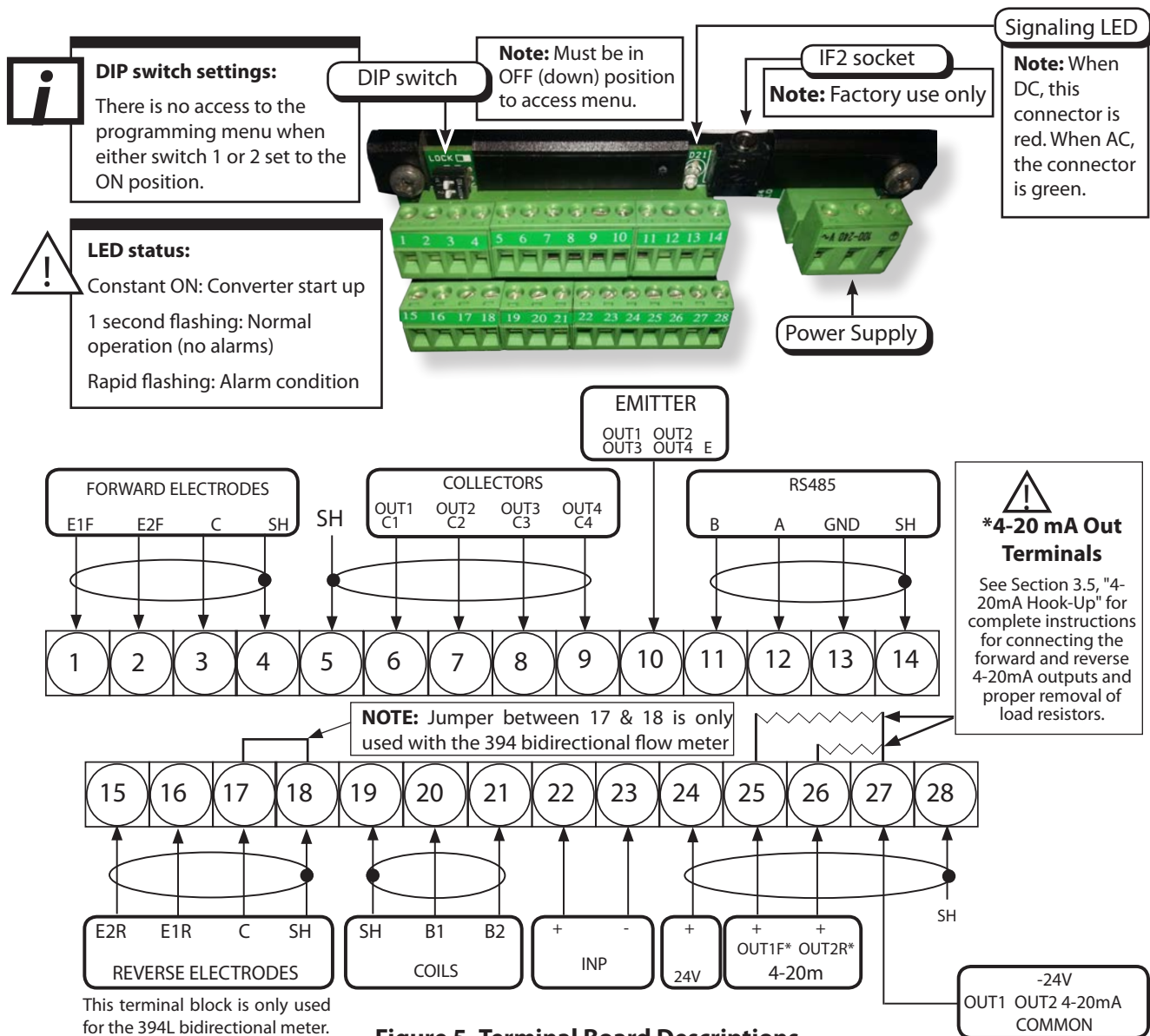

Figure 5. Terminal Board Descriptions

ELECTRICAL CABLE CONNECTIONS

3.2 FPI Mag 394L Bidirectional Cable Connections



***IMPORTANT:** See Section 3.4, "Converter Grounding", Figure 8 for instructions on attaching the chassis ground wire to the converter ground lug.



***IMPORTANT:** The 394 Bidirectional meter wiring requires a jumper between terminals 17 and 18. See note in Figure 5.

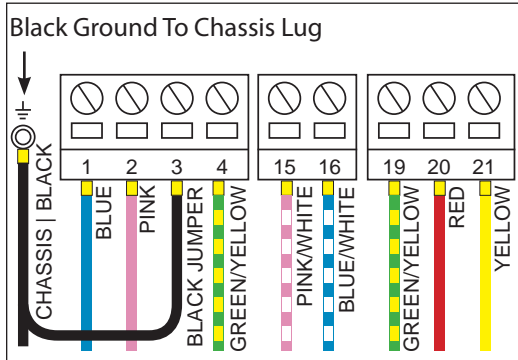

Figure 6. FPI Mag 394L Sensor Cable Connections

Terminal Block Assignments

Cable	Terminal	Wire Color
A	#1 (E1F)	Blue
A	#2 (E2F)	Pink
A	#4 (SH)	Green/Yellow
A	#15 (E2R)	Pink/White
A	#16 (E1R)	Blue/White
B	Chassis Lug & 3(C)	Black
B	#19 (SH)	Green/ Yellow
B	#20 (B1)	Red
B	#21 (B2)	Yellow

Cable Diameters:

Cable A (15039): 0.300"

Cable B (15036): 0.248"

3.3 FPI Mag 395L Forward Only Cable Connections

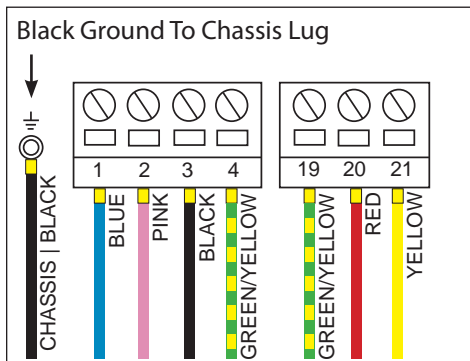

Figure 7. FPI Mag 395L Sensor Cable Connections

Cable	Terminal	Wire Color
A	#1 (E1F)	Blue
A	#2 (E2F)	Pink
A	#3 (C)	Black
A	#4 (SH)	Green/Yellow
B	Chassis Lug & 3(C)	Black
B	#19 (SH)	Green/ Yellow
B	#20 (B1)	Red
B	#21 (B2)	Yellow

Cable Diameters:

Cable A (15035): 0.248"

Cable B (15036): 0.248"

3.4 Converter Grounding

The sensor cable has a ground wire fitted with a loop. Attach the wire with the loop to the enclosure's ground terminal lug as shown in Figure 8.

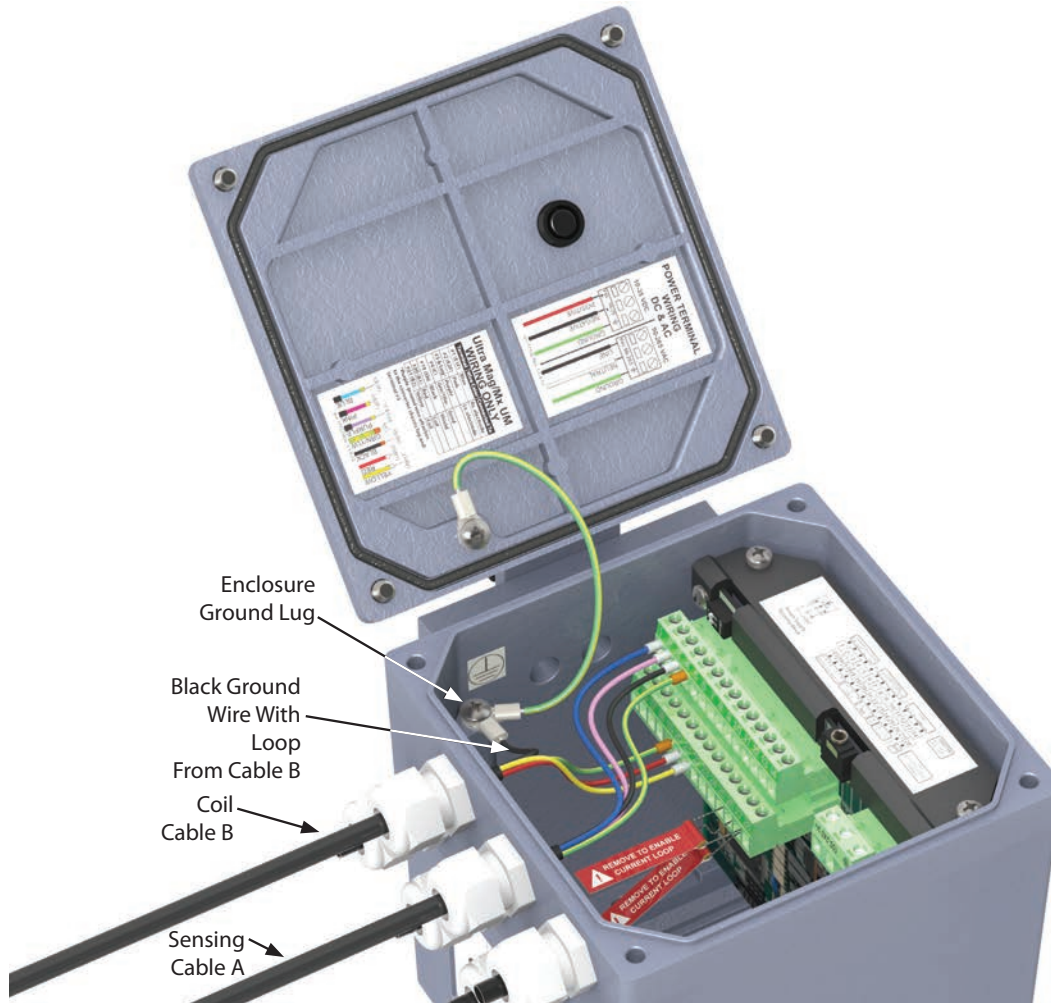

Figure 8. Converter Grounding With Cable Lug

ELECTRICAL CABLE CONNECTIONS

3.5 4-20mA Hook-Up

Isolated 4-20mA current loops are used to output flow data to external devices. Maximum load impedance is 1,000Ω, and the maximum voltage without load is 27VDC. The converter has the capability to detect a loss of load on this output. To disable this function set the value "mA Val. Fault" under the ALARMS menu to zero (see section 7.4). A graphical example of the usage of the current loop with external device is shown below:

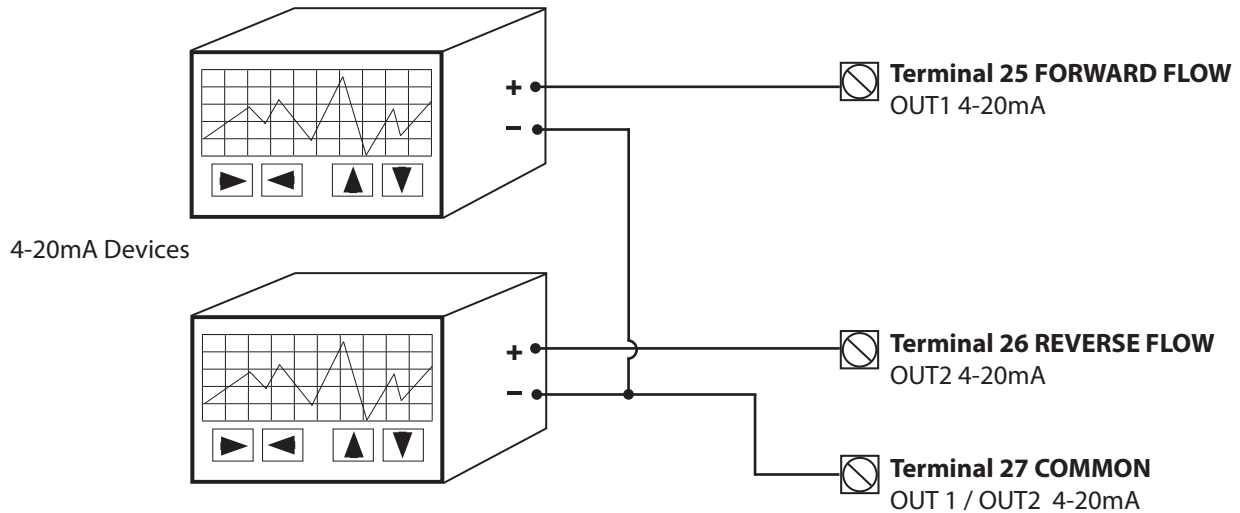

Figure 9. 4-20mA Hook-Up

IMPORTANT - RESISTOR REMOVAL FOR 4-20mA OUTPUTS

It is required to remove the resistors from terminals 25 & 27 and/or 26 & 27 before attaching 4-20mA cables.

FORWARD FLOW: Remove the resistor from terminals 25 and 27.

REVERSE FLOW: Remove the resistor from terminals 26 and 27.

See Section 3.1, "Terminal Board", Figure 5.

If the external device requires a voltage input, a precision resistor placed across the input terminals of the external device will change the current to voltage. Calculate the required resistor using Ohm's law ($V = I \times R$). For example, a 250Ω resistor will provide an input voltage of one to five volts with the transmitter range being set from 4mA to 20mA. An additional 4 to 20mA loop output is available.

IMPORTANT

The converter powers the 4-20mA loops. Do not use external power for the 4-20mA loop as it may cause permanent damage to the converter.

3.6 Opto-Isolated Pulse Output Hook-Up

The four outputs are open collector transistor outputs used to communicate with or activate external devices when the flow reaches a predetermined set point.

- Opto-isolated output with collector and emitter terminals floating and freely connectable
- Maximum switching voltage: 40 VDC
- Maximum switching current: 100mA
- Maximum saturation voltage between collector and emitter 1.2V@100mA
- Maximum switching frequency (load on the collector or emitter, $R_L=470\Omega$, $V_{OUT}=24VDC$): 1250Hz
- Maximum reverse current bearable on the input during an accidental polarity reversion (VEC): 100mA
- Insulation from other secondary circuits: 500 V

Example 1: A common application using all four outputs to exhibit four unique signals

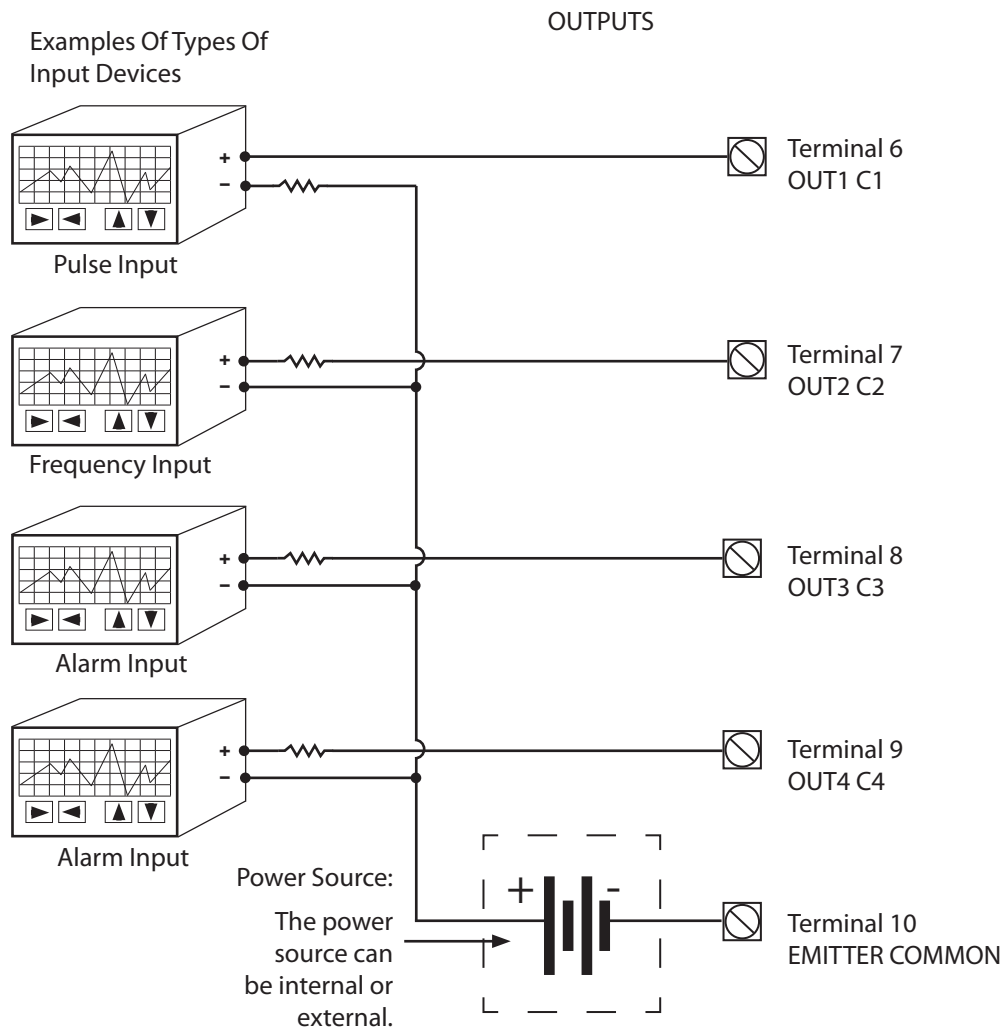

Figure 10. Opto-Isolated Pulse Output Diagram



IMPORTANT

Outputs are not isolated from each other. All outputs **MUST** use the same power source.

ELECTRICAL CABLE CONNECTIONS

Example 2: A common application using one output with one positive signal (+24V from PLC)

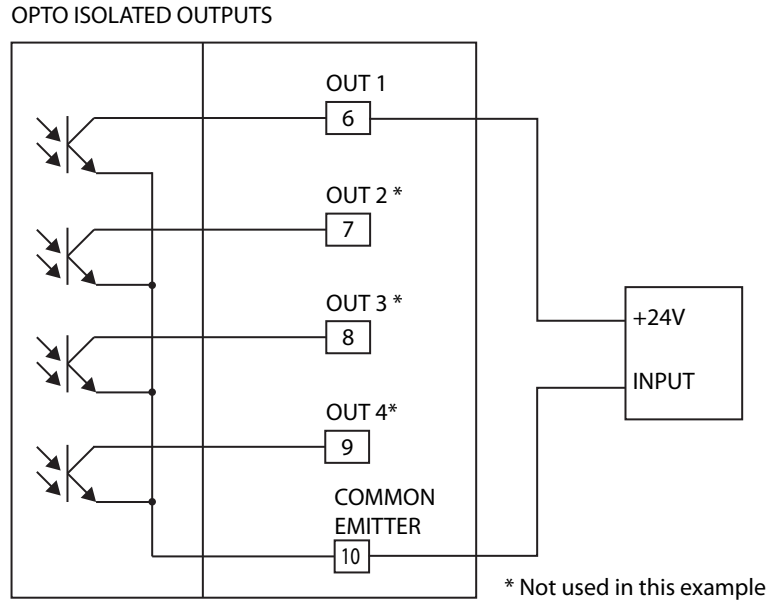

Figure 11. Opto-Isolated Pulse Output Diagram

3.7 Opto-Isolated Pulse Input

- Opto-isolated pulse input
- 500 V isolation
- 2-40 VDC on voltage
- Input programming per input menu, will perform functions set to ON.

Input example:

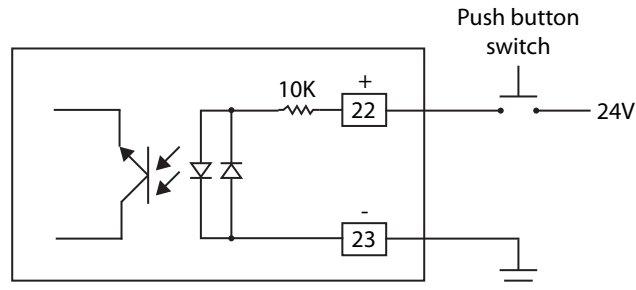

Figure 12. Opto-Isolated Pulse Input Diagram

3.8 Converter Power Hook-Up



WARNING!

Hazardous supply voltage can shock, burn, or cause death.

The power supply line must be equipped with external surge protection for current overload (fuse or circuit breaker with limiting capacity not greater than 10A). It must be easily accessible for the operator and clearly identified.

Power connection is made using the power terminal block on the upper right side of the terminal board.

NOTE: The terminal block unplugs from the circuit board for easy connection. Connect earth ground to the protective grounding terminal before making other connections. The power supply of a standard converter is 90-265VAC, 44-66Hz at maximum 20W. DC converter is available as an option.

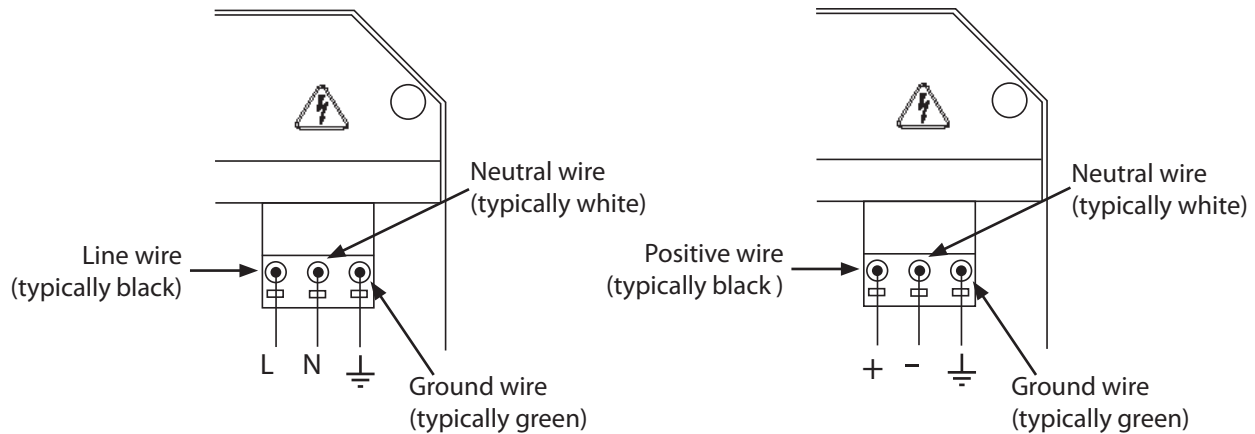

Figure 13. AC Power Supply Terminal Block

Figure 14. Optional DC Power Supply Terminal Block

4.0 CONVERTER START-UP - ALL SENSORS

Before starting up the converter please verify the following:

- Power supply voltage must correspond to that specified on the data plate (located on the side of the converter)
- Electric connections must be wired as described in this manual
- Ground connections must be properly installed

When the converter is powered it initiates a verification cycle of the converter. During the verification cycle the converter displays an incrementing diagnostic number. When the diagnostic is complete, if an error is found, an error number will be displayed referencing the chart at the back of this manual. A text message will also be displayed on the alarm screen.

NOTE: To view alarms, press the RIGHT arrow key from the main display screen.

4.1 Menu Navigation

To navigate through the menus on the converter, the keys on the keypad use the following conventions:

Key:

Function:

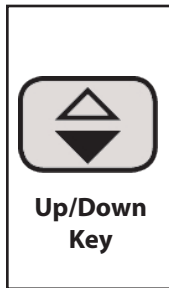

UP/DOWN KEY (for moving cursor up or down)

SHORT PRESSING (< 1 SECOND):

Moves the cursor up to the previous subject on the menu
Increases the numeric figure of the parameter highlighted by the cursor

LONG PRESSING (> 1 SECOND):

Moves the cursor down to the next subject on the menu
Decreases the numeric figure of the parameter highlighted by the cursor



RIGHT/LEFT KEY (for moving cursor right or left)

SHORT PRESSING (< 1 SECOND):

Moves the cursor to the right on the input field
Moves the cursor to the following subject of the menu
Changes the display of the process data

LONG PRESSING (> 1 SECOND):

Moves the cursor to the left on the input field
Moves the cursor to the previous subject on the menu

Note: Push and hold for eight seconds to cycle through contrast settings.



ENTER/ESC KEY (for changing settings)

SHORT PRESSING (< 1 SECOND):

Opens the Quick Start menu for the instrument configuration
Enters the selected function
Cancels the selected function under progress

LONG PRESSING (> 1 SECOND):

Confirms the selected function
Leaves the current menu

Figure 15. Converter Key Conventions

CONVERTER START-UP - ALL SENSORS

4.2 Front Panel Display



Push to change to the next screen display. Each button press changes the screen and cycles through the six displays shown below.

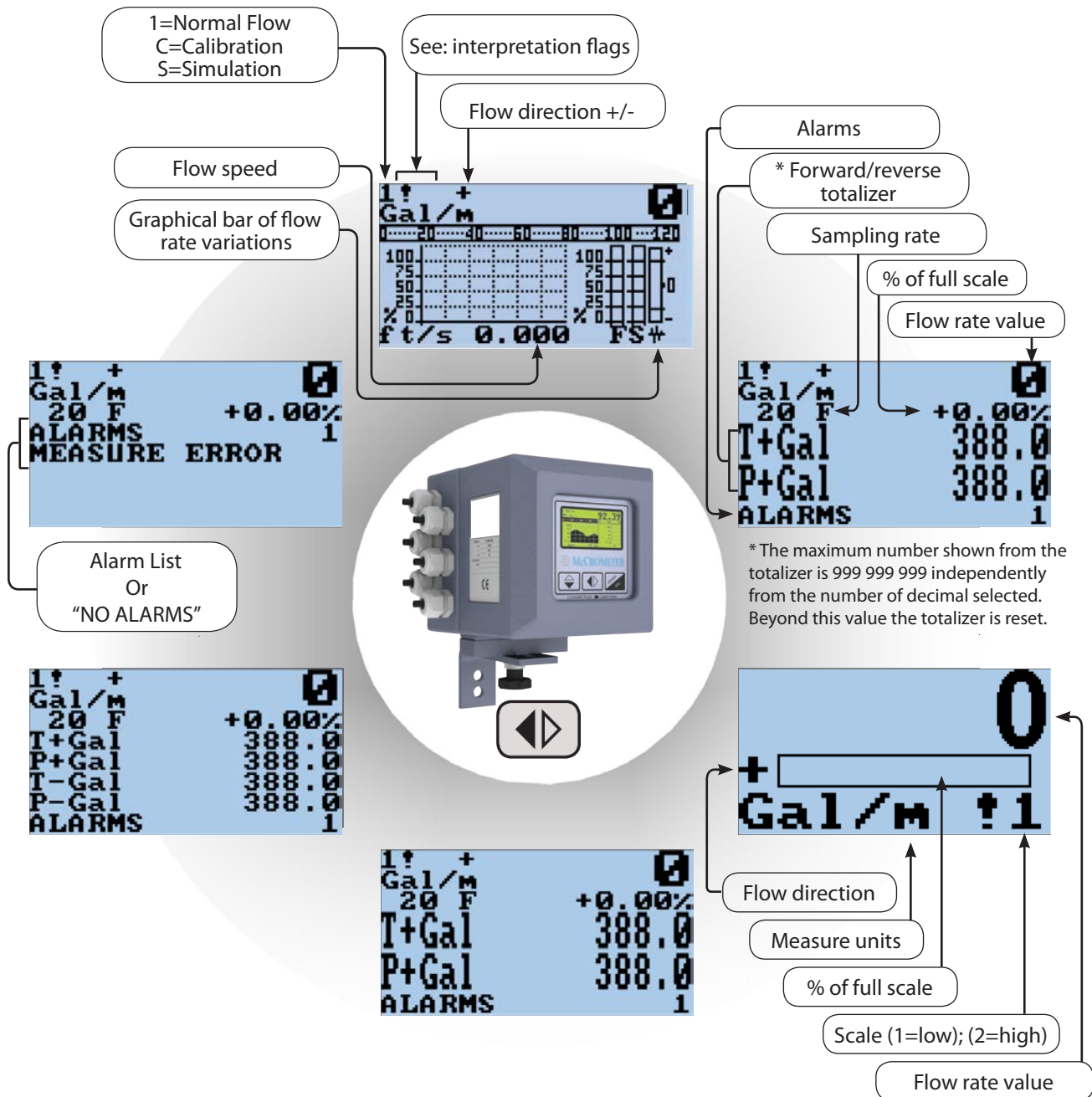

INTERPRETATION FLAGS	
FLAGS	DESCRIPTION
↕	Alarm maximum or minimum activated
!	- Interruption coils circuit - Signal error - Empty pipe
⌋	Pulse output saturation (reduce TIME PULSE)



NOTE: Visualization of the pages can change depending on which functions are enabled or disabled.

CONVERTER START-UP - ALL SENSORS

4.3 M-Series Menu Structure

The following is the menu structure for the M-Series converter. NOTE: Some menus change as options are enabled.

4.4 Factory Set Key Code

The converter is delivered with key code L2 = **000002**, and with the "Quick start menu" enabled. Press the Enter/Esc key. The "Quick start" menu can be enabled or disabled. See section 7.8 to access this function.

With access code L2 = 000000, the request of the code is disabled. See section 7.11 to change the factory set key code.

0. Quick Start

Fs1=
 Tot.MU=
 Pls1=
 Pls2=
 Tpls1=
 Tpls2=
 Frq1=
 Frq2=
 ND=
 Cut-off=%
 KS=
 Simulation=
 Contrast=
 Language=
 Main menu= *

* To access the full menu structure, select **Main menu**, enter 000002, and press Enter. See section 4.4.



ATTENTION!

It is very important to record any customized code as it CANNOT be retrieved if it is lost!



5.0 PROGRAMMING EXAMPLE

The steps below demonstrate how to modify the full scale value from 3500 Gal/m to 3000 Gal/m from the "Quick start menu".

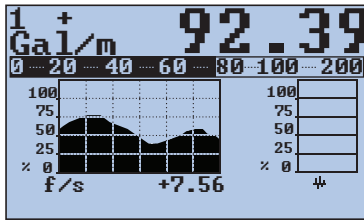

Enter the "Quick Start Menu"



Access the function "Fs1"

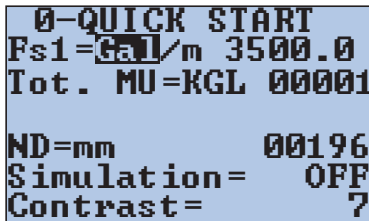

Push Repeatedly

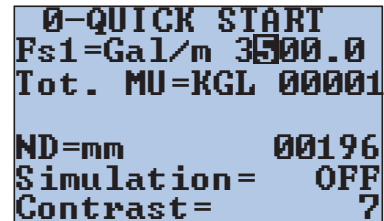

Change the value



Confirm the new value with a short press



Long push to exit to the main page

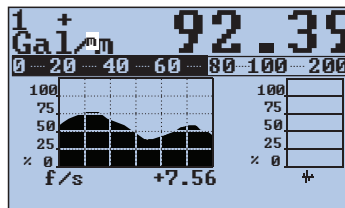

Main visualization page

6.0 MENU 0 - QUICK START

NOTE: The Quick Start menu is configured at the factory. Some menus may not be available in your configuration. If the quick start menu is not present as the first menu option, then it has been disabled (see section 7.8 in the Display Menu). The instructions that follow explain each menu position within the Quick Start menu.

FS1

The Full Scale range 1. The units of measure and full scale range of the meter that defines the 20mA output. Generally this value is set 10% over the anticipated max flow. US standard & metric units are selectable from this menu.

To change the full scale value, highlight the "Fs1" menu and press the Enter/Esc key. The unit will highlight. Press the Up/Down key to scroll thru the different available units. See Appendix 1.0 for available units of measure.



Once you have selected the desired unit press the Right/Left key twice to highlight the lower case letter that represents the time unit. Again press the Up/Down key to scroll thru the available time units. Once the unit of measure and time unit have been selected press the Right/Left key to select the numeric value. Pressing the Up/Down key to set the digit and Right/Left key to move to the next digit.



Once the desired value is entered press the Enter/Esc key to exit/highlight the menu.

If a unit you are looking for is not in the current list press the Right/Left key and scroll to the "/" between the unit of measure and time unit selections and press the Up/Down key to switch between U.S. Standard and Metric units.



Once the desired value is entered quick push the Enter/Esc key to highlight the entire line and then long push Enter/Esc to exit back to the display.

MENU 0 - QUICK START

Tot. MU

The totalizer unit/multiplier as well as the visible decimal place is set here.

To change the totalizer unit/multiplier select the "Tot. MU" menu by highlighting the menu and press the Enter/Esc key. This will highlight the unit/multiplier. See Appendix 1.0 for available units of measure.

```
0-QUICK START
Fs1=Gal/m 009000
Tot.MU:Gal 00001
Pls1=Gal 1.00000
Tpls1=ms 0050.00
ND=mm 00305
Simulation= OFF
Contrast= 5
```

```
0-QUICK START
Fs1=Gal/m 009000
Tot.MU:Gal 00001
Pls1=Gal 1.00000
Tpls1=ms 0050.00
ND=mm 00305
Simulation= OFF
Contrast= 5
```

Press the Up/Down key to scroll through the available units until the desired unit has been selected.

NOTE: The totalizer multiplier is built into the unit of measure, so for gallons multiplied by 1000, select Kgal.

Once the unit of measure is selected press the Right/Left key twice to highlight the numeric value to the right. Then press the Up/Down key to change the decimal resolution displayed for this totalizer. Changing the decimal resolution will not change the multiplier. The available selections are 00001, 001.0, 01.00, and 1.000.

```
0-QUICK START
Fs1=Gal/m 009000
Tot.MU:Gal 00001
Pls1=Gal 1.00000
Tpls1=ms 0050.00
ND=mm 00305
Simulation= OFF
Contrast= 5
```

```
0-QUICK START
Fs1=Gal/m 009000
Tot.MU:Gal 001.00
Pls1=Gal 1.00000
Tpls1=ms 0050.00
ND=mm 00305
Simulation= OFF
Contrast= 5
```

If the desired unit of measure is not in the current list, press the Right/Left key and scroll to the blank space between the unit/multiplier and the numeric decimal resolution selection and press the Up/Down key to switch between U.S. Standard and Metric units.

```
0-QUICK START
Fs1=Gal/m 009000
Tot.MU:Gal 0001.0
Pls1=Gal 1.00000
Tpls1=ms 0050.00
ND=mm 00305
Simulation= OFF
Contrast= 5
```

Pls1

The pulse increment value and unit of measure for the pulse output 1. This option is only available when "out1" in Menu 6 - Outputs 8.6.1 is set to "#1 IMP".

Pls2

The pulse increment value and unit of measure for the pulse output 2. This option is only available when "out2" in Menu 6 - Outputs 8.6.2 is set to "#2 IMP".

Tpls1

Duration of the pulse output 1 expressed in milliseconds. This option is only available when out1 in Menu 6 - Outputs 8.6.1 is set to #1 IMP+. The pulse duration can be set from .4 to 9999.99.



IMPORTANT

The converter cannot detect the type of device it is connected to so it is up to the user to verify the setting is compatible with the external device receiving the pulse. Incorrect settings can damage the receiving device. See section 7.6, "Menu 6 - Outputs" for output specifications.

Tpls2

Duration of the pulse output 1 expressed in milliseconds. This option is only available when out2 in "Menu 6 - Outputs" is set to #2 Freq. The pulse duration can be set from .4 to 9999.99.

ND

Inside Pipe Diameter. The inner diameter of the pipe entered in millimeters. Setting the ND value to zero will cause the converter to display the velocity instead of flow rate. Totalizer will then increment in feet or meters. **NOTE:** Nominal pipe size and the pipe inside diameter are in most cases different from one another. The calculation of a paired FPI Mag system is derived from the pipe inside diameter. Ensure the correct value is supplied for a properly calibrated system.

Cut-off

Cutoff point which all flow is reported as zero. This value is set as a percentage of the full scale.

Simulation

Simulation enable. Setting this menu to ON will generate an internal signal that simulates flow and allows the outputs and all connected instruments to be tested. After simulation is set to ON, the flow can be set to a percentage based on the current FS1 setting -125% to 125%.

To enable the simulation function, use the Right/Left key to highlight the Simulation menu and press the Enter/Esc key, you will be prompted for code L2. Use the Up/Down and Right/Left keys to enter the code 00002. Then press the Enter/Esc key to enter the code.

```

0-QUICK START
Fs1=Gal/m 009000
Tot.MU=Gal 001.0
Pls1=Gal 1.00000
Tpls1=ms 0050.00
ND=mm 00305
Simulation= OFF
Contrast= 5
    
```

```

0-QUICK START
Fs1=Gal/m 009000
Tot.MU=Gal 001.0
Pls1=Gal 1.00000
Tpls1=ms 0050.00
ND=mm 00305
Code [L2] *****
Contrast= 5
    
```

The simulation function can now be toggled from OFF to ON by using the Up/Down key. Select ON to turn on the Simulation mode and press the Enter/Esc key.

```

0-QUICK START
Fs1=Gal/m 009000
Tot.MU=Gal 001.0
Pls1=Gal 1.00000
Tpls1=ms 0050.00
ND=mm 00305
Simulation: OFF
Contrast= 5
    
```

```

0-QUICK START
Fs1=Gal/m 009000
Tot.MU=Gal 001.0
Pls1=Gal 1.00000
Tpls1=ms 0050.00
ND=mm 00305
Simulation: ON
Contrast= 5
    
```

MENU 0 - QUICK START

Press and hold the Enter/Esc key to exit back to the visualization page.

NOTE: There will now be a "S" in the upper left corner, this indicates the simulation mode is active.



Press the Enter/Esc key. This will bring up the flow simulation set up screen. Use the Right/Left key and the Up/Down key to enter in the flow rate percentage value for the simulation. Press the Enter/Esc key to enter that value.

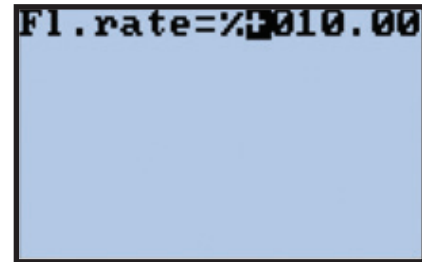

The converter will start to read flow. It may take a few seconds for the readings to appear. Repeat the above steps as needed to observe the different flow rates desired.

To exit out of simulation mode, re-enter into the simulation set up screen (see above) and then press and hold the Enter/Esc key. This will exit out to the visualization screen, and the "S" in the upper left corner of the screen will return to a "1".

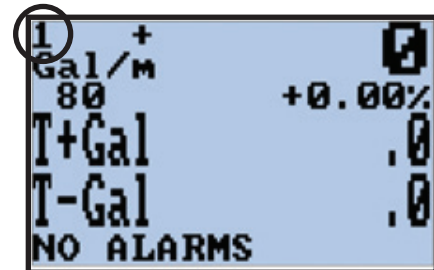

Contrast

Display contrast set point. The display contrast can be changed to make the display appear more visible based on the users preference. This menu can be set 0 to 15 with the change only taking affect once the menu selection has been selected by pressing the enter key. The factory default is 5.

NOTE: If set too high or too low the display can become unreadable. If this happens wait 60 seconds from the time of the last button push for the display to time out to the visualization page. From the visualization page press and hold the Right/Left button. The display will cycle through a different preset display contrast settings every 8 seconds. Release the button once you have found a setting that can be read.

Language

Choose a language to display the converter menus in.

The available options are EN = English, IT = Italian, FR = French, SP = Spanish and DE = German.

Main menu

This allows access to the main menu which contains advanced configuration menus.

NOTE: If the Quick Start menu is disabled, from the flow visualization press the Enter/Esc. The L2 passcode screen will appear. Enter the passcode of 000002, then press the Enter/Esc key.

7.0 MAIN MENU DESCRIPTIONS

Press the key Enter/Esc key to go to the Main menu directly when the "Quick start menu" is disabled. When it is not disabled you can select the Main menu from the "Quick start menu". The functions in the Quick Start menu and the Main menu are explained below. Please note that some functions are only displayed if other functions are enabled or with the insertion of additional modules.

7.1 Menu 1- Sensor

ND Inside Pipe Diameter

The inner diameter of the pipe entered in millimeters. **NOTE:** The flow accuracy will only be as good as the accuracy of the actual pipe ID entered into the converter. The "Nominal Pipe Size" often referred to can be different from the actual pipe ID and if used cause a substantial error in flow reading. Setting the ND value to zero will cause the converter to display the velocity instead of flow rate. Totalizer will then increment in feet or meters.

KA

Factory calibrated gain for the forward flow. Do not change the value.

KA-

Factory calibrated gain for the reverse flow. Used ONLY for bidirectional meters. Do not change the value.

Cable length

Cable length set in increments of 10 meters, rounded to the nearest 10 meter increment.

S. rate

Factory calibrated frequency sampling rate. Do not change the value.

E.P. Detect

Set the empty pipe alarm to on or off. Factory default = ON.

NOTE: Setting the E.P. Detect to "off" can cause the sensor to display environmental/electrical noise as flow.

E.cleaning

Factory set value. Do not change the value.

E.p. thr

Empty Pipe Threshold is the numeric value selected during the Empty Pipe Calibration function. In some cases it may be required to manually adjust this value to be more compatible with an installation. For assistance adjusting this value contact McCrometer Technical Support. Available settings are from 0-250.

Zero Cal.

Zero point calibration function for the forward flow.

To perform the Zero point Calibration select the Zero Cal. Menu by highlighting the menu and press the Enter/Esc key. This will enable the zeroing function. You will see a percent value that is positive or negative.

i **IMPORTANT** - The water must be perfectly still before starting the Zero Cal process or an offset will be introduced into the flow report.

```
1-SENSOR
Cable len.=m 010
S.rate=Hz    20
E.P.detect=  ON
E.I.signal=  000
E.p.thr.=   250
Zero cal.
Zero- cal.
```

```
1-SENSOR
Cable len.=m 010
S.rate=Hz    20
E.P.detect=  ON
E.I.signal=  000
E.p.thr.=   250
Measuring... 685
Zero- cal.
```

MAIN MENU DESCRIPTIONS

Now press and hold the Up/Down button and release when the message "Measuring. . ." appears. The converter counts up from zero to 1,000, after which the zero point is set. The new value should be less than before the autozero was performed. If not, then verify that there is no flow in the pipe and repeat.

```
1-SENSOR
Cable len.=m 010
S.rate=Hz    20
E.P.detect=  ON
E.I.signal=  000
E.p.thr.=    250
%            +0.0000
Zero-cal.
```

Zero Cal.

Zero point calibration function for the reverse flow. See above instructions and repeat for the reverse zero calibration.

MAIN MENU DESCRIPTIONS

7.2 Menu 2 - Scales

FS

The Full Scale range 1. The full scale units of measure of the meter that defines the 20mA output and the general maximum flow for the meter. U.S. Standard and metric units are selectable from this menu. See Appendix 1.0 for available units of measure.

To change the full scale value, highlight the "Fs1" menu and press the Enter/Esc key. The unit will highlight. Press the Up/Down key to scroll thru the different available units.

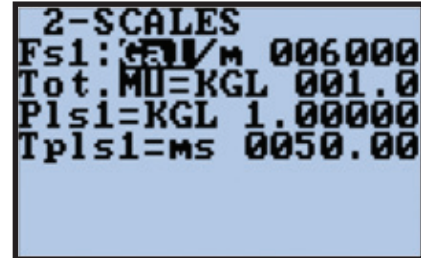
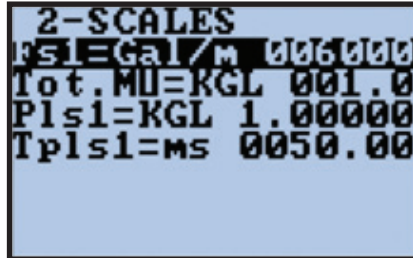

Once you have selected the desired unit press the Right/Left key twice to highlight the lower case letter that represents the time unit. Again press the Up/Down key to scroll thru the available time units. Once the unit of measure and time unit have been selected press the Right/Left key to select the numeric value. Press the Up/Down key to set the digit and the Right/Left key to move to the next digit.

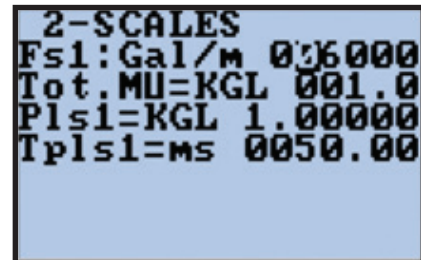
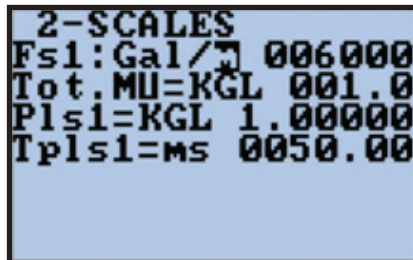

If a unit you are looking for is not in the current list press the Right/Left key and scroll to the "/" between the unit and time unit selection and press the Up/Down key to switch between U.S. standard & metric units.

Once the desired value is entered quick push Enter/Esc to high light the entire line and then long push Enter/Esc to exit back to the display.

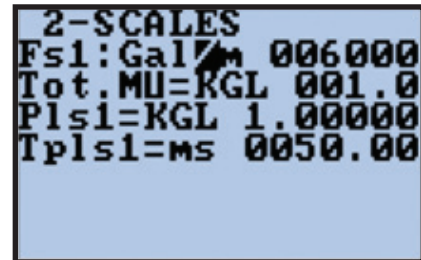

Tot. MU

Totalizer Multiplier Unit. To change the Totalizer Multiplier unit select the "Tot. MU" menu by highlighting the menu and press the Enter/Esc key. This will highlight the unit/multiplier line. See Appendix 1.0 for available units of measure.

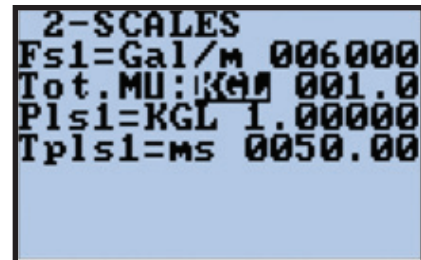
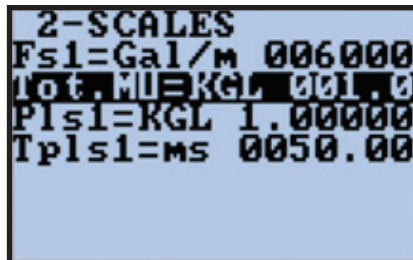

MAIN MENU DESCRIPTIONS

Press the Up/Down key to scroll thru the different available units until the desired unit has been selected. **NOTE:** the totalizer multiplier is built into the unit of measure so if you want gallons times 1000 you must select Kgal. Once selected, press the Right/Left key twice to highlight the numeric value to the right. Pressing the Up/Down key will change the decimal resolution displayed for this totalizer but will not change the multiplier. The available selections are 00001, 001.0, 01.00, and 1.000.

```

2-SCALES
Fs1=Gal/m 006000
Tot.MU:KGL 00000
Pls1=KGL 1.00000
Tpls1=ms 0050.00
    
```

```

2-SCALES
Fs1=Gal/m 006000
Tot.MU:KGL 00000
Pls1=KGL 1.00000
Tpls1=ms 0050.00
    
```

If a unit you are looking for is not in the current list press the Right/Left key and scroll to the blank space between the unit/multiplier and the numeric decimal resolution selection and press the Up/Down key to switch between US standard & metric units.

NOTE: Maximum Fs1 value is equivalent to 33.418 FPS.
Minimum Fs1 value is equivalent to 1.337 FPS.

NOTE: Converter will only accept settings based on possible max setting less than 99999.
Example: 35" Line ND = 889 mm max
Flow rate = 10220 GPM
Converter will not accept GPM/M. Unit must be entered as KGL/M.

```

2-SCALES
Fs1=Gal/m 006000
Tot.MU:KGL 001.00
Pls1=KGL 1.00000
Tpls1=ms 0050.00
    
```

Pls1

The pulse increment value and unit of measure for the pulse output 1. This option is only available when "out1" in "Menu 6 - Outputs" (section 7.6) is set to "#1 IMP".

Pls2

The pulse increment value and unit of measure for the pulse output 2. This option is only available when "out2" in "Menu 6 - Outputs" (section 7.6) is set to "#2 IMP".

Tpls

Duration of the pulse output 1 expressed in milliseconds. This option is only available when out1 in Menu 6 - "Menu 6 - Outputs" (section 7.6) is set to "#1 IMP". The pulse duration can be set from .4 to 9999.99.

Tpls2

Duration of the pulse output 1 expressed in milliseconds. This option is only available when out2 in Menu 6 - "Menu 6 - Outputs" (section 7.6) is set to "#2 IMP". The pulse duration can be set from .4 to 9999.99.

Frq1

Full scale frequency value for output 1. This option is only available when out1 in "Menu 6 - Outputs" (section 7.6) outputs is set to "#1 Freq (+/-)". The value is set in hertz between 0.1 to 1,000.0.

Frq2

Full scale frequency value for output 2. This option is only available when out2 in "Menu 6 - Outputs" (section 7.6) is set to "#2 FREQ (+/-)". The value is set in hertz between 0.1 to 1,000.0.

IMPORTANT



The converter cannot detect the type of device it is connected to so it is up to the user to verify the setting is compatible with the external device receiving the pulse. Incorrect settings can damage the receiving device. See section 7.6, "Menu 6 - Outputs", for output specifications.

7.3 Menu 3 - Measure

Damping

This sets the dampening or filter setting for the meter. This setting is extremely important. The correct filter setting ensures the proper response of the meter to the measured flow rate. The available dampening filter values range from 0 (no dampening or dampening OFF) to a maximum dampening of 1,000 seconds. There are also some specialized settings, SMART 1, SMART 2, and SMART 4, which dampen small flow variations but react more aggressively to large variations. With the dampening turned off the converter responds immediately to any change in flow. This can result in a noisy output and should only be used in batching operations where flow rates are highly regulated and incremental quantities of flow are small. With the dampening set to values between 0.2 seconds and 1000 seconds the converter buffers and averages flow data over the period of time specified. Larger values tend to provide a quieter and more stable output but will respond more sluggishly to large changes or transitions in flow rate. The specialized, SMART settings are not intended for use with the FPI, SPI, or UltraMag flow meters and should not be selected. Typically, the FPI, SPI, and UltraMag meters are set with a damping of 10 seconds. This setting can be changed to make the meter more or less responsive and/or stable. To make large changes to the setting please contact the factory to understand the application specific consequences of doing so.

Cut-off

Cutoff point which all flow is reported as zero. This value is set as a percentage of the full scale. (Note: Default cut-off point = 2.0% of full scale.)

7.4 Menu 4 - Alarms

Max Thr +

Max Thr +, Maximum flow threshold, forward flow. This is the set point to trigger a high flow alarm set as a percentage of full scale. This function is disabled when set to zero.

Max Thr -

Maximum flow threshold, reverse flow. This is the set point to trigger a high flow alarm set as a percentage of full scale. This function is disabled when set to zero.

Min thr +

Minimum flow threshold, forward flow. This is the set point to trigger a low flow alarm set as a percentage of full scale. This function is disabled when set to zero.

Min thr -

Minimum flow threshold, reverse flow. This is the set point to trigger a high flow alarm set as a percentage of full scale. This function is disabled when set to zero.

Hyst.

Alarm Hysteresis. Set 0-25%. This sets the lag in response based on a percentage of the full scale. Example if the alarm triggers at 100% and the hysteresis is set to 2% then once triggered the current rate must change beyond 2% to exit out of the current alarm state. This setting applies to all alarms.

mA v. fault

mA value fault. Current output value during alarm events set as a percentage 0-120% of the current output range. The current range 0/4mA to 20/22mA is set in "Menu 6 - Outputs" (section 7.6). For example, if an empty pipe alarm is present and the mA v. fault value is set to 10% and the current scaling is set 4 to 20mA, then the current output would send a 2mA signal until the empty pipe alarm is cleared. This function is disabled when set to zero.

Hz v. fault

Hertz value fault. Frequency output value during alarm events set as a percentage 0-125% of the frq1/frq2 range. For example, if an empty pipe alarm is present and the Hz v. fault value is set to 110% and the Frq1 scaling is 100 Hz, then the frequency output on channel 1 would send a 110 Hz signal until the empty pipe alarm is cleared. This function is disabled when set to zero.

7.5 Menu 5 - Inputs

T+ reset

Positive Totalizer Reset Enable. Set by turning on or off. This allows for the positive total totalizer to be reset through the input.

T- reset

Negative Totalizer Reset Enable. Set by turning on or off. This allows for the negative total totalizer to be reset through the input.

Puls.reset

Pulse Output Reset Enable. Set by turning on or off. This allows for the totalized pulses to be reset through the input.

Count lock

Totalizer Count Lock Input Enable, Set by turning on or off. This allows for the totalizers to be locked (frozen) when the input is active.

7.6 Menu 6 - Outputs

Out 1

Transistor output channel 1. See tables on the next page for available settings.

Out 2

Transistor output channel 2. See tables on the next page for available settings.

Out 3

Transistor output channel 3. See tables on the next page for available settings.

Out 4

Transistor output channel 4. See tables on the next page for available settings.

Out mA1

Current output channel 1. See tables on the next page for available settings.

Out mA2

Current output channel 2. See tables on the next page for available settings.

MAIN MENU DESCRIPTIONS

Outputs available for open collector transistor outputs #1 & #2 only:

Function Symbol	Function Explanation
#1 IMP+	Pulse on output 1 for forward flow rate. Only assignable to channel 1. This option will trigger 1 pulse per PLS1 setting.
#1 IMP-	Pulse on output 1 for reverse flow rate. Only assignable to channel 1. This option will trigger 1 pulse PLS1 setting.
#1 IMP	Pulse on output 1 for forward and reverse flow rate. Only assignable to channel 1. This option will trigger 1 pulse per PLS1 setting.
#2 IMP +	Pulse on output 2 for forward flow rate. Only assignable to channel 2. This option will trigger 1 pulse per PLS2 setting.
#2 IMP -	Pulse on output 2 for reverse flow rate. Only assignable to channel 2. This option will trigger 1 pulse per PLS2 setting.
#2 IMP	Pulse on output 2 for forward and reverse flow rate. Only assignable to channel 2. This option will trigger 1 pulse per PLS2 setting.
#1 FREQ+	Frequency on output 1 for forward flow rate. Only assignable to channel 1. This option will trigger a frequency output for forward flow per Frq1 setting.
#1 FREQ-	Frequency on output 1 for reverse flow rate. Only assignable to channel 1. This option will trigger a frequency output for reverse flow per Frq1 setting.
#1 FREQ	Frequency on output 1 for forward and reverse flow rate. Only assignable to channel 1. This option will trigger a frequency output for both forward and reverse flow per Frq1 setting.
#2 FREQ+	Frequency on output 2 for forward flow rate. Only assignable to channel 2. This option will trigger a frequency output for forward flow per Frq2 setting.
#2 FREQ-	Frequency on output 2 for reverse flow rate. Only assignable to channel 2. This option will trigger a frequency output for reverse flow per Frq2 setting.
#2 FREQ	Frequency on output 2 for forward and reverse flow rate. Only assignable to channel 2. This option will trigger a frequency output for both forward and reverse flow per Frq2 setting.

Outputs available for open collector transistor outputs #1 through #4.

Function Symbol	Function Explanation
SIGN	Flow direction output (energized = reverse flow)
RANGE	Not Supported
MAX AL+	Max. forward flow rate output (energized = alarm off) per max thr + setting
MAX AL-	Max. reverse flow rate output (energized = alarm off) per max thr - setting
MAX AL	Max. forward and reverse flow rate output (energized = alarm off) per both max thr + and - setting
MIN AL+	Min. forward flow rate output (energized = alarm off) per min thr + setting
MIN AL-	Min. reverse flow rate output (energized = alarm off) per min thr - setting
MIN AL	Min. forward and reverse flow rate output (energized = alarm off) per both min thr + and - setting
MAX+MIN	Max. and min. flow rate alarm output (energized = alarm off) per both max and min settings
EMPTY PIPE	Empty pipe alarm output (energized = alarm off) per EP detect and EP thr settings
OVERFLOW	Out of range alarm output (energized = flow rate is in range) per FS1 setting
Hardw AL.	Cumulative alarm output; interrupt coils, empty pipe, and/or measure error (energized = alarms off)
EXT. COMM.	Not Supported

MAIN MENU DESCRIPTIONS

CURRENT VALUES IN mA ASSOCIATED TO THE % VALUE OF FULL SCALE					
POSSIBLE FIELD	REVERSE FLOW VALUE		ZERO	DIRECT FLOW VALUE	
	$\leq -110\%$	-100%	0%	+100%	$\geq +110\%$
	OutmA= 0 ÷ 20 +	0	0	0	20
OutmA= 0 ÷ 22 +	0	0	0	20	20
OutmA= 4 ÷ 20 + ¹	4	4	4	20	20
OutmA= 4 ÷ 22 +	4	4	4	20	20
OutmA= 0 ÷ 20 -	20	20	0	0	0
OutmA= 0 ÷ 22 -	22	20	0	0	0
OutmA= 4 ÷ 20 - ²	20	20	4	4	4
OutmA= 4 ÷ 22 -	22	20	4	4	4
OutmA= 0 ÷ 20	20	20	0	20	20
OutmA= 0 ÷ 22	22	20	0	20	22
OutmA= 4 ÷ 20	20	20	4	20	20
OutmA= 4 ÷ 22	22	20	4	20	22
OutmA= 0 ÷ 20 —0+	0	0	10	20	20
OutmA= 0 ÷ 22 —0+	0	1	11	21	22
OutmA= 4 ÷ 20 —0+	4	4	12	20	20
OutmA= 4 ÷ 22 —0+	4	4.8	12.8	20.8	22

1 Default mA1 setting

2 Default mA2 setting

7.7 Menu 7 - Communication

IF2 pr.

Protocol for IF2 port. Set to DPP or HTP. This sets the protocol used for communication to the IF2 device, either Data Packet Protocol (DPP) or Hyper Text Protocol (HTP). Default is DPP.

RS485 bps

RS485 output speed. This sets the RS485 baud rate (4800, 9600, 19200, or 38400).

A. delay

Instrument answer delay. This sets the answer delay in microseconds (0, 20, 40, 60, 80, 100, 120, or 140).

Address

DEVICE ADDRESS (0 to 255) – This sets the address of the device for RS485 communication.

Rem.addr

REMOTE ADDRESS (0 to 255) – This sets the address of a second remote converter.

Remote u.conn

REMOTE CONNECTION – Pressing this connects the remote terminal. The connection will be interrupted after 10 seconds of inactivity

MAIN MENU DESCRIPTIONS

7.8 Menu 8 - Display

Language

Converter language. This sets the converter language EN (English), IT (Italian), FR (French), SP (Spanish), or DE (German).

Contrast

Display contrast set point. The display contrast can be changed to make the display appear more visible based on user preference. This menu can be set 0 to 15. The change will take affect once the menu selection has been selected by pressing the Enter/Esc key. The factory default is 5.

NOTE: if set too high or too low the display can become unreadable. If this happens then wait 60 seconds from the time of the last button push for the display to time out to the visualization page. From the visualization page press and hold the Right/Left button. The display will cycle through a different preset display contrast settings every 8 seconds. Release the button once you have found a setting that can be read.

Quick start

Quick Start Menu Enable. This setting toggles between on and off. If set to "off" it will hide the quick start menu.

Net total

Totalizer Net Enable. This setting toggles between on and off. Setting this menu to "on" will replace the current forward and reverse totalizers with the net totalizers on the visualization.

T+ reset

Totalizer reset, forward. Resets the forward flow totalizer.

T- reset

Totalizer reset, reverse. Resets the reverse flow totalizer.

To reset the totalizer, highlight the totalizer reset option to be reset. Quick press the Enter/Esc key. The display will show "EXECUTE?". Press and hold the Enter/Esc key to continue. The display will flash "Done". The visualization pages will now show the totalizer as reset.

NOTE: There is no function to reset the Net Totalizer. To reset the Net Totalizer, both the "+" and the "-" totalizers must be reset.

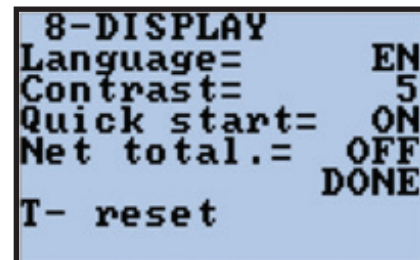

7.9 Menu 9 - Data Logger

YYYY/MM/DD

Date and time. This sets the date and time in the converter. The format for entering the date and time is year / month / day and time is hours : minutes : seconds.

Acquisition

Event logger for internal alarms. This setting toggles between on and off. This menu enables event logging to capture alarm events internally for diagnostic purposes. This data can't be extracted.

Display events

Displays the stored alarm events in order, up to a maximum of 64 events.

Clear events

Clears all stored events.

7.10 Menu 10 - Diagnostics

Calibration

Initiates the calibration of the converter. To activate press the Enter key and then, at the question: "EXECUTE?" press the Esc key to start calibration, or any other key for escape back. During the calibration process a "C" is displayed in the upper left corner of the display.

Self-test

Converter self test. Executed command. Running the self-test will cause the converter to run an internal diagnostic test that will check for internal hardware and software errors. The converter will reboot. Once the self-test is complete if any errors are found then the error code for each error will be displayed. Refer to section 8.0, "ALARM MESSAGES", for a list of possible error codes.

Simulation

Simulation enable. Setting this menu to ON will generate an internal signal that simulates flow and allows the outputs and all connected instruments to be tested. After simulation is set to ON, the flow can be set to a percentage based on the current FS1 setting of -125% to 125%.

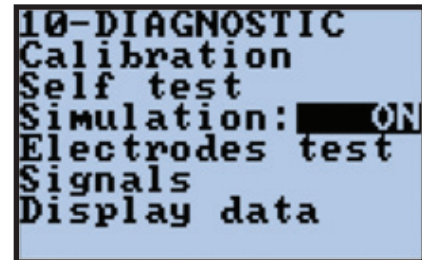
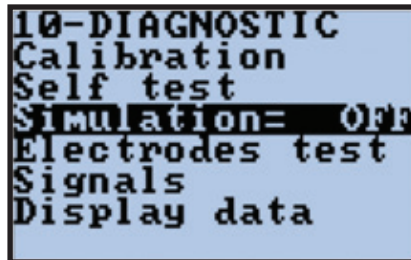

To enable the simulation function highlight the Simulation menu and press the (enter/esc) key. Toggle the simulation function from OFF to ON using the Up/Down key. Press and hold the (enter/esc) key to exit back to the main menu and once again to exit to the visualization page.

NOTE: you will now have an "S" in the upper left corner, this indicates the simulation mode is active.

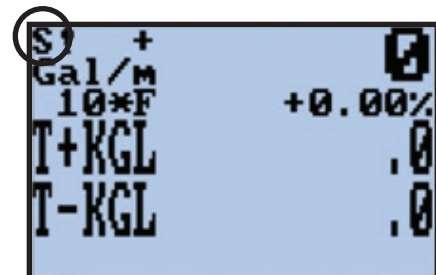

MAIN MENU DESCRIPTIONS

Press the Enter/Esc key. This will bring up the flow simulation set up screen. Use the Right/Left key and the Up/Down key to enter in the flow rate percentage value for the simulation. Press the Enter/Esc key to enter that value.

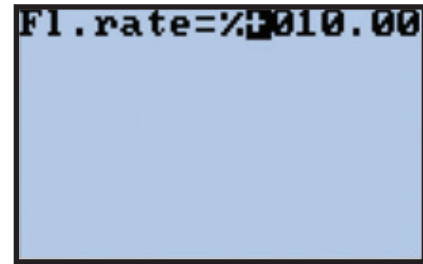

The converter will start to read flow. It may take a few seconds for the readings to appear. Repeat the above steps as needed to observe the different flow rates desired.

To exit out of simulation mode, re-enter into the simulation set up screen (see above) and then press and hold the Enter/Esc key. This will exit out to the visualization screen, and the "S" in the upper left corner of the screen will return to a "1".

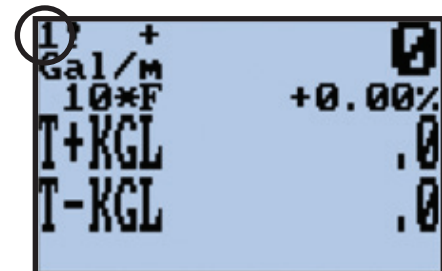

Electrodes test

Executed function. This function tests the internal electrode circuits for proper operation. This is a factory service menu.

Signals

This menu displays graphical representations to various input and output signals. This is a Factory service menu.

Display data

Numeric display for various internal settings and raw measured signals. This is a Factory service menu.

7.11 Menu 11 - Internal Data

L2 code

Level 2 passcode. This menu changes the 2 level passcode. The factory default is 000002.



CAUTION - if the passcode is changed from the default value and is lost, it CANNOT be recovered. In the event the passcode is lost the converter can be returned to the factory to be reset. Note all data is lost during this process.

Load fact. Pres.

Load factory presets. This is an executed menu. Executing this menu will reset all programmed values to the original factory default values.

NOTE: This menu is customized for a specific sensor. Confirm the converter has not been moved or paired with another sensor prior to executing this menu.

Load user pres.

Load User Presets. This is an executed menu. Executing this menu will reset all programmed values to a user defined set of programming values. These values are set using the "Save user pres." Menu.

To reload the factory or user presets select the desired set of presets by highlighting the menu and press the Enter/Esc key.

```
11-INTERNAL DATA
L2 code= ******
Load fact.pres.
Load user pres.
Save user pres.
KS=      +01.0000
KZ=      +000000
KZ-=     +000000
```

```
11-INTERNAL DATA
L2 code= ******
Load fact.pres.
Load user pres.
Save user pres.
KS=      +01.0000
KZ=      +000000
KZ-=     +000000
```

You will be asked if you want to "execute?" the function. Press and hold the Enter/Esc key. This will load the saved preset values. The display will flash "DONE" once the converter has finished reprogramming the preset values.

```
11-INTERNAL DATA
L2 code= ******
EXECUTE?
Load user pres.
Save user pres.
KS=      +01.0000
KZ=      +000000
KZ-=     +000000
```

```
11-INTERNAL DATA
L2 code= ******
DONE
Load user pres.
Save user pres.
KS=      +01.0000
KZ=      +000000
KZ-=     +000000
```

MAIN MENU DESCRIPTIONS

Save user pres.

Saves user presets. This is an executed menu.

To save a user defined program start by reviewing each and every programming menu and confirm that each value is set as desired. Once it is confirmed the programming is set as desired, navigate to the "Save user pres." menu and press the Enter/Esc key. You will be prompted if you want to "execute?". Press and hold the Enter/Esc key and the display will flash "DONE". Your user defined presets have now been saved and can be recalled anytime by executing the "Load user pres." function.

```
11-INTERNAL DATA
L2 code= *****
Load fact.pres.
Load user pres.
Save user pres.
KS= +01.0000
KZ= +000000
KZ-= +000000
```

```
11-INTERNAL DATA
L2 code= *****
Load fact.pres.
Load user pres.
Execute?
KS= +01.0000
KZ= +000000
KZ-= +000000
```

```
11-INTERNAL DATA
L2 code= *****
Load fact.pres.
Load user pres.
DONE
KS= +01.0000
KZ= +000000
KZ-= +000000
```

KS

Field adjustment coefficient. This value is a direct multiplier that is used as a field adjustment/correction coefficient.

KZ

Forward zero point coefficient. The forward zero point coefficient is selected when the zero calibration is run. This menu will allow for manual adjustments of the forward zero point.

KZ-

Reverse zero point coefficient. Used ONLY for forward and reverse sensors. The reverse zero point coefficient is selected when the zero calibration is run. This menu will allow for manual adjustments of the reverse zero point.

DAC1 20mA

Current output channel 1 20 mA trim. This is a factory service menu.

DAC1 4mA

Current output channel 1 4 mA trim. This is a factory service menu.

DAC2 20mA

Current output channel 2 20 mA trim. This is a factory service menu.

DAC2 4mA

Current output channel 2 4 mA trim. This is a factory service menu.

ALARM MESSAGES

8.0 ALARM MESSAGES

During meter setup, you may see error messages and codes. These messages and codes are explained below.

MESSAGES	ANOMALIES	ACTION TO TAKE
NO ALARMS	Everything works regularly	-----
MAX ALARM	The flow rate is higher than the maximum threshold set	Check the maximum flow rate setting and process conditions. (Menus Max Thr and +Fs1)
MIN ALARM	The flow rate is lower than the minimum threshold set	Check the minimum flow rate threshold setting and process conditions. (Menu +Fs1)
FLOW RATE >FS	The flow rate is higher than the full scale value set on the instrument	Check the full scale value setting on the instrument and the process conditions/ (Menu Fs1)
PULSE/FREQ .FS	The output channel is saturated.	Set a bigger frequency unit or, if the connected counting device allows it, reduce the pulse duration value. (Menu Tpls)
EMPTY PIPE	The measuring pipe is empty or the detection system has not been properly calibrated	Check whether the pipe is empty.
INPUT NOISY or MEASURE ERROR	The measure is strongly effected by external noise or the cable connecting the converter to the sensor is broken	Check the status of the cables connecting the sensor, the grounding connections of the devices or the possible presence of noise sources
EXCITATION FAIL	The coils or the cable connecting the sensor are interrupted	Check the connecting cables to the sensor
CURR. LOOP OPEN	The 0/4-20ma output on board or the optional one are not correctly closed on a valid load	Verify the load is applied to the output (max 1000 ohm) or a resistor is in place. To disable the alarm, set the "mA VAL.FAULT" value (menu alarm) to 0.

ERROR CODES	ANOMALY DESCRIPTION	ACTION TO TAKE
0001	Problem with watch-dog circuit	ADDRESS TO FACTORY TECHNICAL SUPPORT
0002	Wrong configuration work data in EPROM	
0004	Wrong configuration safety data in EPROM	
0008	Defective EPROM	
0010	Defective keyboard (one or more keys are pushed during the test)	
0020	Power supply voltage (+3.3) is out of range	
0040	Power supply voltage (+13) is too low (<10V)	
0080	Power supply voltage (+13) is too high (>14V)	
0200	Timeout calibration input (input circuit is broken)	
0400	Gain input stage is out of range	
0800	Interruption on the coils circuit	Check the status of the cables connecting the sensor to the converter
0C00	Cumulative alarm 0800+0400	See single code

9.0 SPECIFICATIONS

POWER REQUIREMENTS:

AC: 90-265 VAC / 45-66 Hz (20W/25VA) or
DC: 10-35 VDC (21 W)
AC or DC must be specified at time of ordering.

CERTIFICATIONS:

ISO 9001:2015
CE compliant
WRAS (pending)



STANDARD OUTPUTS:

Single ¹ or Dual ² 4-20mA Outputs: Galvanically isolated and fully programmable for zero and full scale (0-21mA rangability)

Two ¹ or Four ² separate digital programmable outputs: open collector transistor usable for pulse, frequency, or alarm settings.

- Volumetric Pulse
- Flow Rate (Frequency)
- Hardware Alarm
- High/Low Flow Alarms
- Empty Pipe
- Directional Indication
- Range Indication

Maximum switching voltage: 40 VDC
Maximum switching current: 100mA
Maximum switching frequency: 1250 Hz
Insulation from other secondary circuits: 500V

OPTIONAL OUTPUT:

Modbus (available with Single or Dual 4-20mA)

ENGINEERING UNITS

Cubic Meter; Cubic Centimeter; Milliliter; Liter; Cubic Decimeter; Decaliter; Hectoliter; Cubic Inches; US Gallons; Imperial Gallons; Cubic Feet; Kilo Cubic Feet; Standard Barrel; Oil Barrel; US Kilogallon; Ten Thousands of Gallons; Imperial Kilogallon; Acre Feet; Megagallon; Imperial Megagallon; Hundred Cubic Feet, Megaliters

STANDARDS:

IP67 Die Cast Aluminum Converter

ELECTRICAL CONNECTORS:

Converter: Compression gland seals for 3.1 mm (0.125") to 9.5 mm (0.375") Diameter round cable.

GALVANIC ISOLATION:

All inputs / outputs are galvanically isolated from power supply up to 500V

CONVERTER ENCLOSURE:

IP67 Die Cast Aluminum
5.76" H x 5.76" W x 6.73" D
(14.6 cm. H x 14.6 cm. W x 17 cm D)

ENVIRONMENTAL:

Pressure / Temperature Limits:
Electronics: Operating and storage temperature:
-4° to 140° F (-20° to 60° C)
Sensor is continuously submersible (IP68), with a standard quick-connect cable to 1.8 m (6'), and optional strain relief at 9.1 m (30').

KEYPAD AND DISPLAY:

Can be used to access and change set-up parameters using three membrane keys and an LCD display

M-Series OPTIONS FORWARD AND BIDIRECTIONAL:

RS485 Modbus Protocol

***NOTE REGARDING CABLE LENGTH:** McCrometer recommends minimizing cable length. Electromagnetic flow meters may have unfavorable signal strength to noise ratio in electrically noisy environments. Longer lengths of cable increase the likelihood of interference. In those cases where the meter's signal must be transmitted a long distance, or where the environment may be particularly noisy, we suggest using the converter's analog output(s). That allows locating the converter as close as possible to the metering location.

RETURNING A UNIT FOR REPAIR

10.0 RETURNING A UNIT FOR REPAIR

If the unit needs to be returned to the factory for repair, please do the following:

- Prior to calling for a return authorization number, determine the model number, serial number (located inside the front panel of converter), and reason for return.
- Call the McCrometer Customer Service Department at 1-800-220-2279 and ask for a Return Authorization (RA) number.
- Ship the meter in the original packaging, if possible. Do not ship manuals, power cords, or other parts with your unit unless required for repair.
- Please make sure the meter is clean and free from foreign debris prior to shipping.
- Write the RA number on the outside of the shipping box. All return shipments should be insured.
- Address all shipments to:

McCrometer, Inc.
RMA #
3255 W. Stetson Avenue
Hemet, CA 92545

11.0 TROUBLESHOOTING GUIDE

Problem	Troubleshooting Steps
Not getting expected 4-20mA output	<ul style="list-style-type: none"> • Ensure the wiring is firmly connected on the 4-20mA output terminals • Verify the FS1 setting in the Quick Start menu is set to the correct value • Measure output on the 4-20mA terminals and compare it to the calculated current value
Curr. Loop Open Alarm	<ul style="list-style-type: none"> • Ensure the wiring is firmly connected on the 4-20mA output terminals • If the 4-20mA output is not being used, ensure the 4-20mA terminals have a load resistor installed • Remove the wires from the 4-20mA terminals and measure the current output direct
Excitation Fail (0800) Alarm	<ul style="list-style-type: none"> • Ensure the wiring is firmly connected • Disconnect the coil wires from the converter and check their resistance with a standard multi-meter. Contact the factory for the proper value for the sensor. • Ensure the wiring is firmly connected to any PreAmp being used.
Noisy Input Alarm	<ul style="list-style-type: none"> • Verify there is a jumper on terminals 3 and 4 • Verify the converter ground is to earth ground • Check for damaged cable between the sensor and converter
Empty Pipe Alarm	<ul style="list-style-type: none"> • Confirm the pipe is full • Verify there is a jumper on terminals 3 and 4 • Check EP Threshold. Set to 192 if short cable (less than 50 ft.), set to <120 if longer cable (50 ft. to 100 ft.). Consult the factory for assistance in selecting the correct value. • Conduct a bucket test to confirm the EP Threshold value is set correctly. Consult the factory for assistance. • Check for damaged cable between the sensor and converter
Unstable Flow Readings	<ul style="list-style-type: none"> • Check grounding connections • Check power circuit. What other devices are on the circuit • Install dedicated ground circuit
Menu Not Accessible	<ul style="list-style-type: none"> • Confirm the password being used is 000002 • Verify dip switches in the back panel next to the terminals 1 and 2 are both down.
Rate Of Flow Report Is Not As Expected	<ul style="list-style-type: none"> • Confirm the unit is programmed correctly by requesting a program setting report from the factory.

APPENDIX 1.0 UNITS OF MEASURE

APPENDIX 1.0 UNITS OF MEASURE

The tables below show the units of measure available for selection.

U.S. Standard	
in ³	Cubic Inches
Gal	U.S. Gallons
IGL	Imperial Gallons
ft ³	Cubic Feet
kf ³	Thousands of Cubic Feet
bbbl	Standard Barrels
BBL	Oil Barrels
KGL	Kilo Gallons
ttG	Ten Thousands of Gallons
IKG	Imperial Kilo Gallons
kf ³	Kilo Cubic Feet
Aft	Acre Feet
MGL	Mega Gallons
IMG	Imperial Mega Gallons

Metric	
ml	Milliliters
cm ³	Cubic Centimeters
l	Liters
dm ³	Cubic Decimeter
dal	Decaliter
hl	Hectoliter
m ³	Cubic Meter
ML	Megaliter

Time	
s	Seconds
m	Minutes
h	Hours
d	Days

APPENDIX 2.0 CONVERSION TABLES

APPENDIX 2.0 CONVERSION TABLES

Table of Decimal Equivalents

Fraction	Decimal
1/8	.125
1/4	.25
3/8	.375
1/2	.5
5/8	.625
3/4	.75
7/8	.875

Table of Conversions

Multiply	By	To Get
Centimeters	0.3937	Inches
Centimeters	0.03281	Feet
Inches	25.4	Millimeters
Feet	30.48	Centimeters
Square Feet	144.0	Square Inches
Square Inches	0.006944	Square Feet
Cubic Inches	0.0005787	Cubic Feet
Cubic Feet	7.481	Gallons
Cubic Feet	1728.0	Cubic Inches
Cubic Feet	0.02832	Cubic Meters
Cubic Feet	28.32	Liters
Cubic Meters	35.31	Cubic Feet
Cubic Meters	264.2	Gallons
US Gallons	3.785	Liters
US Gallons	0.1337	Cubic Feet
US Gallons	0.003785	Cubic Meters
US Gallons	.8326748	Imperial Gallons
Liters	0.2642	Gallons
$^{\circ}\text{F} = (^{\circ}\text{C} \times 9/5) + 32$	$^{\circ}\text{C} = (^{\circ}\text{F} - 32) \times 5/9$	

WARRANTY STATEMENT

WARRANTY STATEMENT

Manufacturer warrants all products of its manufacture to be free from defects in workmanship and material under normal use and service. The warranty for the **M-Series Converter** extends for a period of twelve (12) months after date of shipment (if the converter is purchased alone), unless altered by mutual agreement between the purchaser and manufacturer prior to the shipment of the product. If the M-Series converter is purchased with a flow sensor system, the Warranty Statement for the flow sensor shall apply.

If this product is believed to be defective and is within its warranty period, purchaser shall notify the manufacturer, and will return the product to the manufacturer, postage paid, within twelve (12) months after date of shipment by the manufacturer. If the purchaser believes the return of the product to be impractical, manufacturer shall have the option, but will not be required, to inspect the product wherever located. In any event, if the purchaser requests the manufacturer visit their location, the purchaser agrees to pay the non-warranty expenses of travel, lodging and subsistence for the field service response. If the product is found by the manufacturer's inspection to be defective in workmanship or material, the defective part or parts will either be repaired or replaced, at manufacturer's election, free of charge, and if necessary the product will be returned to purchaser, transportation prepaid to any point in the United States. If inspection by the manufacturer of such product does not disclose any defect of workmanship or material, manufacturer's regular service repair charges will apply.

THE FOREGOING WARRANTY IS MANUFACTURER'S SOLE WARRANTY, AND ALL OTHER WARRANTIES, EXPRESS, IMPLIED OR STATUTORY, INCLUDING ANY IMPLIED WARRANTY OF MERCHANTABILITY OR FITNESS FOR A PARTICULAR PURPOSE, ARE NEGATED AND EXCLUDED. THE FOREGOING WARRANTY IS IN LIEU OF ALL OTHER WARRANTIES, GUARANTEES, REPRESENTATIONS, OBLIGATIONS OR LIABILITIES ON THE PART OF THE MANUFACTURER.

Purchaser's sole remedy and manufacturer's sole obligation for alleged product failure, whether under warranty claim or otherwise, shall be the aforesaid obligation of manufacturer to repair or replace products returned within twelve months after date of original shipment. The manufacturer shall not be liable for, and the purchaser assumes and agrees to indemnify and save harmless the manufacturer in respect to, any loss or damage that may arise through the use by the purchaser of any of the manufacturer's products.

OTHER  **McCrometer** PRODUCTS INCLUDE:



**Propeller
Flowmeters**



**Differential Pressure
Flowmeters**



**Magnetic
Flowmeters**



**Wireless Monitoring
System**