

## Retrofit Instruction: From Water Specialties FlowCom unit to remote mount FlowConnect unit

### OVERVIEW OF THE PROCEDURE

This describes the procedure for retrofitting a Water Specialties flow meter by replacing a FlowCom unit with a FlowConnect unit while setting up a new remote mount location.

REPLACE THIS

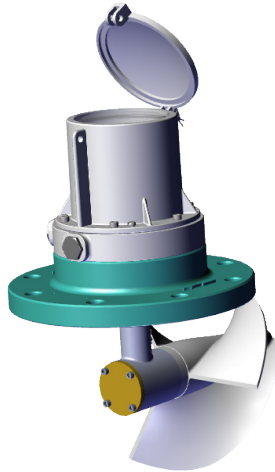

WITH THIS

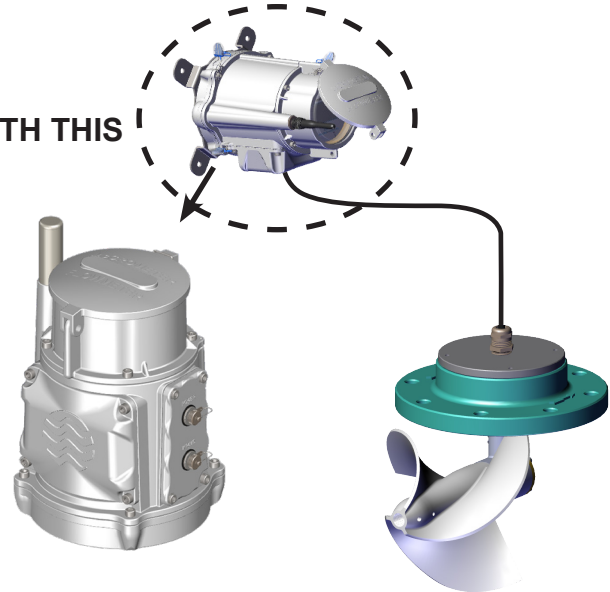

#### 1 - Retrofit Procedure

- STEP 1: Inventory the parts
- STEP 2: Prepare a remote area for the telemetry equipment
- STEP 3: Run power and sensor cables
- STEP 4: Remove the FlowCom unit from the flow meter
- STEP 5: Install sensor cable strain relief in meter head plate
- STEP 6: Attach the FlowConnect unit at the remote mount location
- STEP 7: Attach the antenna
- STEP 8: Connect the batteries and attach the battery cover
- STEP 9: Attach the tamper evident seals

#### 2 - Installing Sensors and Solar Panel

- 1: Recommended standards
- 2: Installing a solar panel
- 3: Installing a rain gauge
- 4: Installing a pressure sensor

#### 3 - Connecting Inputs and Outputs

- 1: Power connector
- 2: Inputs connector
- 3: Outputs connector

#### 4 - Setting the New FlowCom Register

- STEP 1: Enter PROGRAMMING MODE
- STEP 2: Cycle through the first menu level
- STEP 3: Cycle through the second menu level
- STEP 4: Set the total
- STEP 5: Exit and save settings

## PARTS AND MATERIALS

| Part Number | Description                     | Quantity | Part Number | Description                  | Quantity |
|-------------|---------------------------------|----------|-------------|------------------------------|----------|
| 30122-21    | IOM Manual                      | 1        | TOB049      | O-ring, wall mount bracket   | 1        |
| TOB008      | WS Base Plate                   | 1        | 1-2802      | Wall mount bracket           | 1        |
| TOB018      | O-Ring for Base Plate           | 1        | TOB050      | #10-32 screw with O-ring     | 1        |
| R139-00-K   | Remote mount kit:               |          | 15016-10    | Tamper evident seals         | 3        |
| EJ543-00    | FTG CBL PG11 BRS PLT            | 2        | EJ538-00    | Plug PG7                     | 1        |
| 10736       | O-ring 1.5 mm x 16 mm ID EPDM   | 1        | 10015-00    | Desiccant                    | 2        |
| R0139-00    | K adapter for PG11 fitting S316 | 1        | 10804       | Cable tie                    | 2        |
| 10273       | O-ring -021                     | 1        | 10790       | #6 screw x 3/16" SS          | 2        |
| 10274       | O-ring -121                     | 1        |             | Sensor cable(s)              | 1        |
| 1-1707-19   | In-line Terminal 2 Position     | 1        |             | Antenna or antenna extension | 1        |
| 1-1707-18   | In-line Terminal 1 Position     | 1        |             |                              |          |
| 10845       | Shrink wrap tubing              | 3        |             |                              |          |

NOTE: The power and sensor cables cannot be reused. They will need to be replaced with new cables with the appropriate connectors for the FlowConnect unit.

## TOOLS REQUIRED

5/32" hex driver, T-shape wrench recommended  
 Phillips screwdriver  
 Standard flat head screwdriver  
 Precision flat head screwdriver

Wire cutter  
 Ratchet socket driver, 1/2" drive  
 1-3/8" socket

## LOCATION OF ACCESSIBLE COMPONENTS

Figure 1 below shows the location and names of the components you will work with in this IOM.

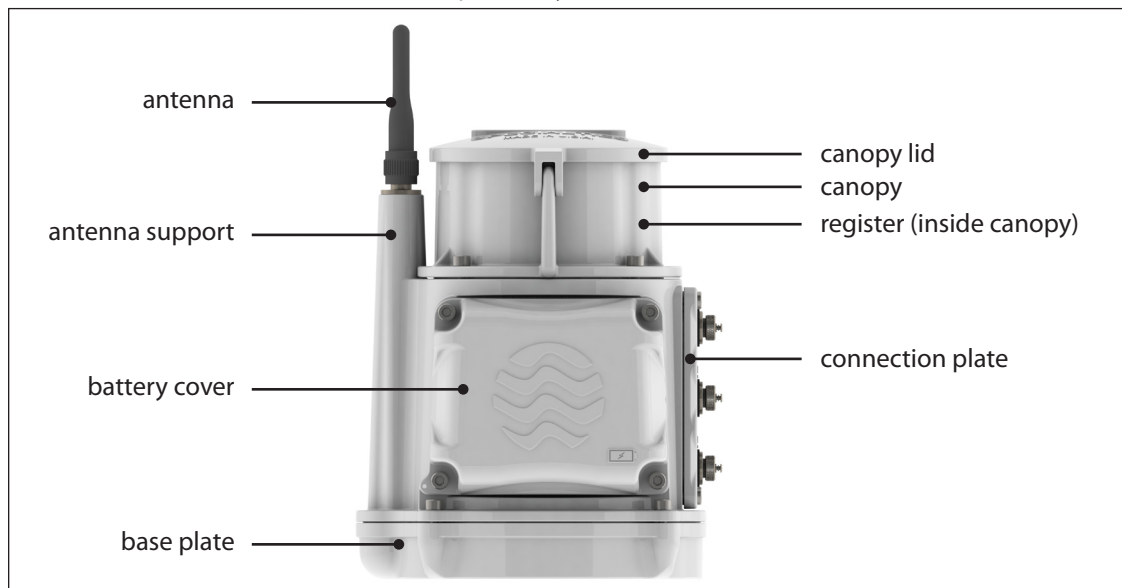

Figure 1. Accessible Components

## 1 - Retrofit Procedure

### STEP 1: Inventory the parts

- Check the parts received against the parts list on the previous page.
- Compare the serial numbers engraved on the lids to confirm they match.
- Confirm the serial number on the FlowConnect unit corresponds to information on a silver label located on the bottom of the base plate.

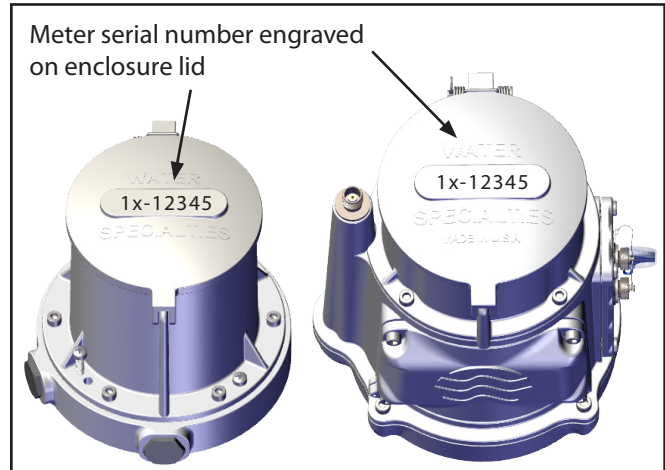

Figure 2. Checking engraved serial numbers on lids

### STEP 2: Prepare a remote area for the telemetry equipment

Depending on your equipment, the wiring diagram may not necessarily represent your exact configuration. For example, if you plan to use rechargeable batteries in your FlowConnect unit, you will need to have a solar panel installed or a 24V DC power supply. If you have any questions about your specific remote mount configuration, contact your McCrometer representative.

### STEP 3: Run power and sensor cables

Run cables from the remote telemetry area to the meter head. At a minimum, you will need to run the sensor cables, and if you plan to install sensors or a solar panel, plan their location at the same time.



*You may run your cables through conduit if you wish. If your cables run through conduit, it may be easier if you run replacement cables before you install a new submersible mount kit at the meter head. This especially applies if you have buried conduit.*

*If your cables do not run through conduit, you only need to make sure the cables are long enough for the full cable run.*



#### **IMPORTANT:**

*The power and sensor cables cannot be reused. They will need to be replaced with new cables with the appropriate connectors for the FlowConnect unit.*

## STEP 4: Remove the FlowCom unit from the flow meter

- a. Remove the four screws around the base.
- b. Lift up and remove the canopy.
- c. Disconnect the wire from the digital register leading into the drive shaft column and remove the FlowCom register entirely.

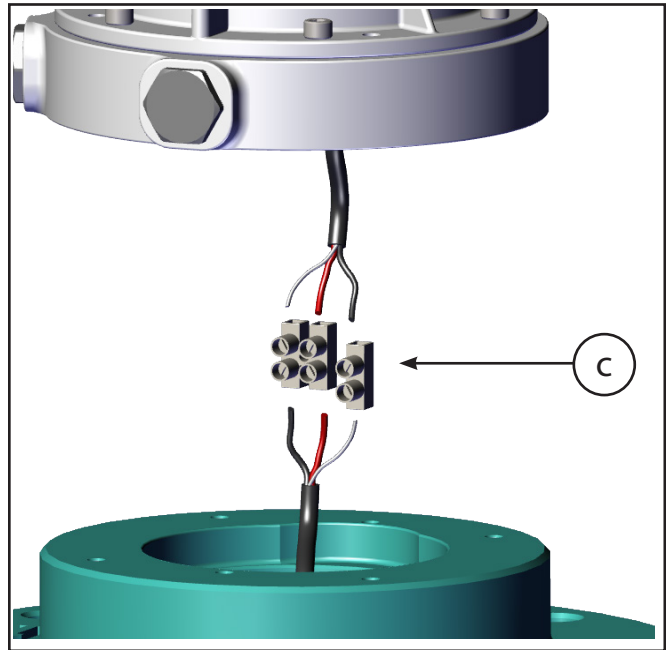
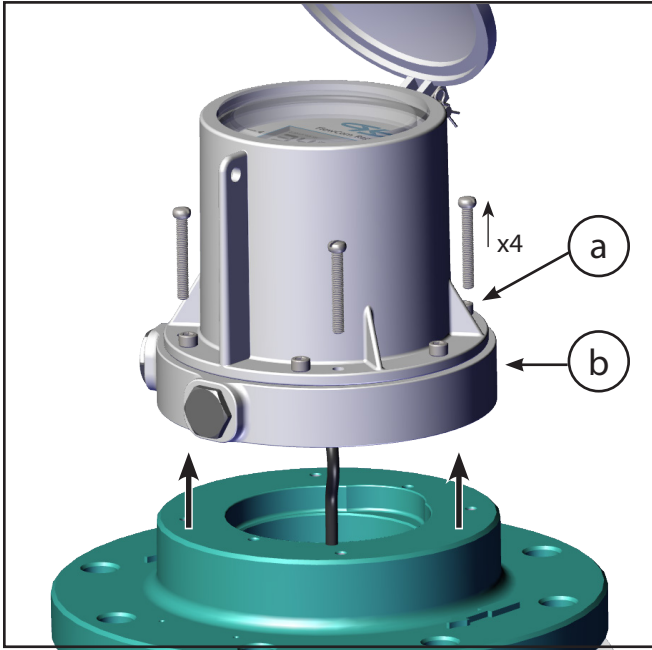

## STEP 5: Install sensor cable strain relief in meter head plate

- a. Pull the FlowCom remote cable through the assembled submersible remote mount kit and out through the bottom.
- b. Using the in-line terminal, connect the FlowCom remote cable to the sensor cable wires, matching the red wires and the black wires.
- c. Guide the in-line terminal block into the neck of the drive shaft column and screw the submersible remote mount kit assembly into the neck of the drive shaft column while holding the remote mount cable. Holding the remote mount cable will prevent the twisting of the sensor cable inside the drive shaft column which can cause the cable termination of the in-line terminal block to be pulled apart.

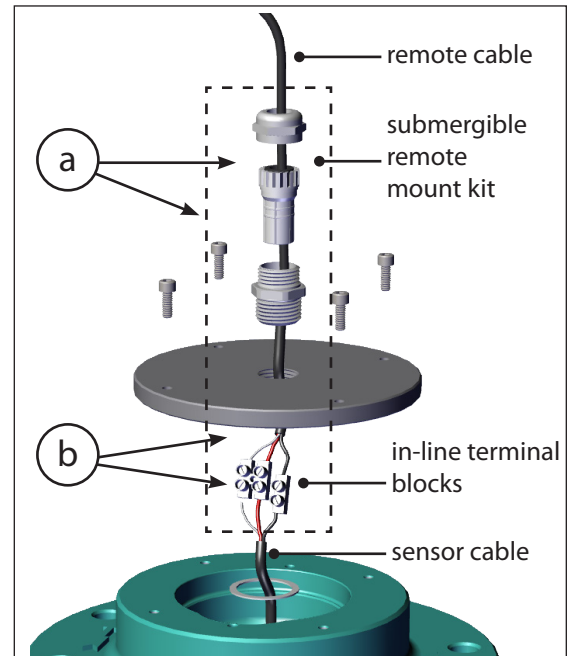

### WARNING!

Over tightening the cable compression seal will damage the internal conductors, causing them to be crushed and shorted together, preventing proper operation.

- d. Tighten down the compression on the submersible assembly kit. Tighten only hand tight plus one half turn.
- e. Reassemble the propeller onto the bearing assembly. Ensure the propeller key is placed in the groove on the bearing before installing the propeller.
- f. Test the conversion by spinning the propeller by hand and ensuring the display changes. Install the meter into the line and mount the remote FlowCom in a convenient location.

## STEP 6: Attach the FlowConnect unit at the remote mount location

Screw or bolt the FlowConnect unit in place in the desired location.

The FlowConnect unit needs to be grounded. When you bolt the FlowConnect unit, use one of the bolts as to connect a grounding wire.

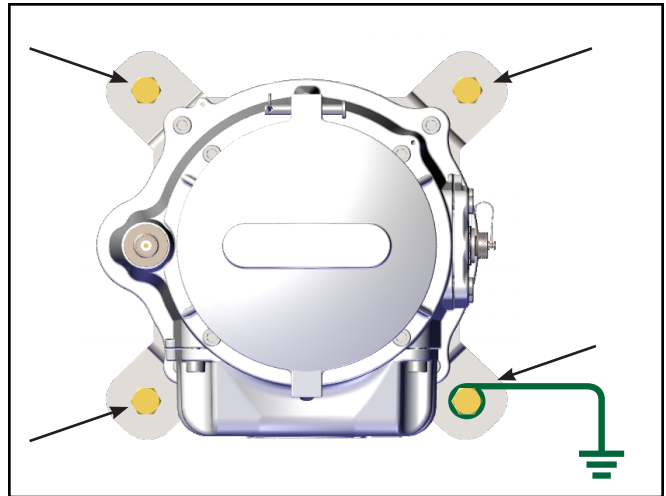

## STEP 7: Attach the antenna



**The antenna *MUST* be attached before the batteries are inserted! Powering up the unit without the antenna may damage the modem!**

Attach the cellular antenna or antenna extension by screwing it to the antenna post.



Figure 3. Attaching the cellular antenna

Figure 4. Attaching the satellite antenna

Figure 5. Attaching the antenna extension



### IMPORTANT!

To ensure good reception for the FlowConnect unit place it in an area that will ensure good coverage.

- FlowConnect Satellite should have view of the sky, especially the horizon.
- FlowConnect Cell should be in an area with good cellular coverage.

## STEP 8: Connect the batteries and attach the battery cover

Connecting the batteries for both non-rechargeable and rechargeable types is identical.

- Remove the battery cover.
- Ensure the batteries are in place and plug the leads into the connectors in the order shown in Figure 6 and Figure 7.

**NOTE: Non-rechargeable batteries must be connected in the order shown at right. Rechargeable batteries come as a single pack of three with one connector.**

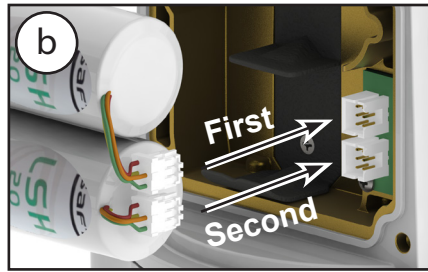

Figure 6. Non-rechargeable batteries

- Replace the battery cover, making sure the O-ring is set in place flat and even, without any twisting.
- Set the cover in position over the battery compartment. It will set easily in place. Tighten the four screws snug and hand tight.

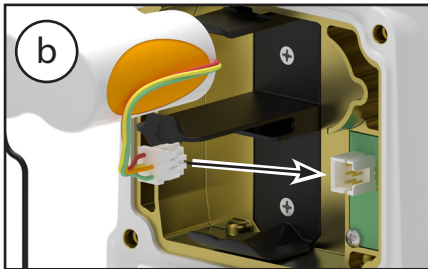
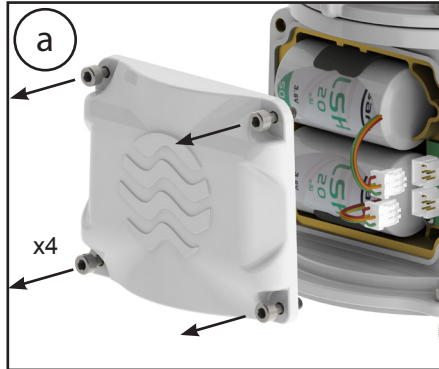
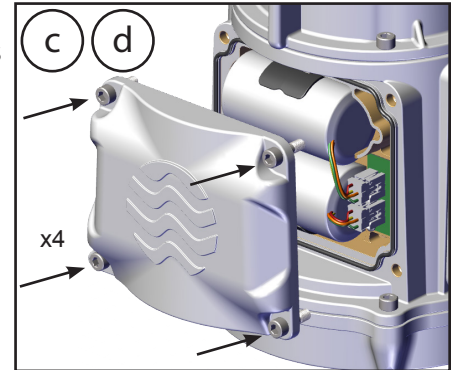

Figure 7. Rechargeable batteries



## STEP 9: Attach the tamper evident seals

When the retrofit is completed, attach the two tamper evident seals located the base plate (Figure 8) and the battery cover (Figure 9). There are already two other seals on the FlowConnect unit.

Each tamper evident seal is attached through the hole in the security screw and a small hole in the chassis next to the security screw.

- Thread the wire end through the security hole in the screw and through the hole in the chassis next to the screw.
- When the wire is fully threaded through, insert the wire through the hole in the center of the blue lock piece, then fold it over the top and down into the center groove.
- Flatten the wire and snap the clasp over the blue lock piece.

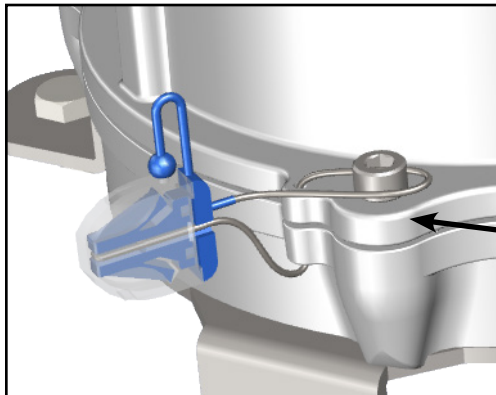

Figure 8. Tamper evident seal on the base plate

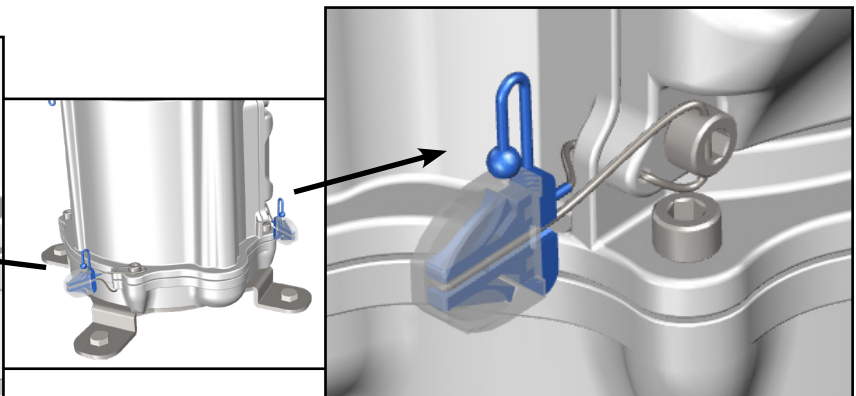

Figure 9. Tamper evident seal on the battery cover

## 2 - Installing Sensors and Solar Panel

The method you use to install a sensor mount will depend on the sensor type and local site conditions. The site location for a pressure sensor, the aerial mast to mount a rain gauge, or the need for cable protection, may vary.

Because each user's requirements and conditions will vary, McCrometer does not require any particular way of mounting or securing the sensor pole. However, we do provide recommended standards for how your sensor mount should be installed. These standards are flexible enough to allow you to install your sensors under most conditions while being able to take into account your local circumstances.

### 1: Recommended standards

#### Pole set

You may choose to use the McCrometer pole set, or you may use a pole set more to your preferences.

#### Pole and aerial height

Height of 5' to 10', elevating an antenna 4' to 5' feet above surrounding obstructions.

#### Pole diameter

Any pole that is 1.25" to 2" in diameter will work with McCrometer sensors.

#### Solar panel orientation

If you are installing a solar panel, orient it so that it is facing south in the northern hemisphere.

#### Securing / anchoring

There are many ways to install and secure an aerial mast for a solar panel, rain gauge, or antenna extension. We recommend installing the mast plumb. The lower part of the mast may be buried or cemented into the ground, or it may be secured to surrounding fixed objects. The installation should be secure enough to withstand the expected environmental conditions (such as strong wind) as well as foot traffic at or near the installation site.

#### Cable protection

We recommend you consider cable protection for use against animals, foot traffic, or vehicle traffic around the installation site. Common methods include the use of metal or flexible conduit sufficient to accommodate the 1/2" connectors used on solar panels and sensor cables.

#### Cable management

It is recommended that you secure sensors or extension cables near any sharp metal edges such as hose clamps.

We also recommend securing cables about every 12" - 18" along the aerial mast.

#### Additional site protection

Some sites may require additional protection from damage from livestock or vandalism. Fencing, cattle guards, or other measures may be necessary.

## 2: Installing a solar panel

### TOOLS AND MATERIALS

#### Tools and Materials:

Solar Panel kit (200.733.522 or 200.733.520)  
7 mm socket driver  
5-pin male to female extension cable

Use a hose clamp and 7 mm socket driver to attach the solar panel to the top of the pole.

Orient the solar panel south so that it gets a maximum amount of light.

Connect the extension cable to the solar panel. When you are finished, the other end of the cable will be plugged into the FlowConnect unit (see next section).

If you are also installing a rain gauge with a solar panel, they should be mounted on the same pole, directly opposite each other (Figure 10).

## 3: Installing a rain gauge

### TOOLS AND MATERIALS

#### Tools and Materials:

Rain Gauge kit, model RG1  
7 mm socket driver  
7-pin male to female extension cable

Use a 7 mm socket driver and two hose clamps to secure the rain gauge to the top of the pole such that the mouth of the rain gauge is level with the end of the pole (Figure 10).

Connect the extension cable to the rain gauge. When you are finished, the other end of the cable will be plugged into the FlowConnect unit (see next section).

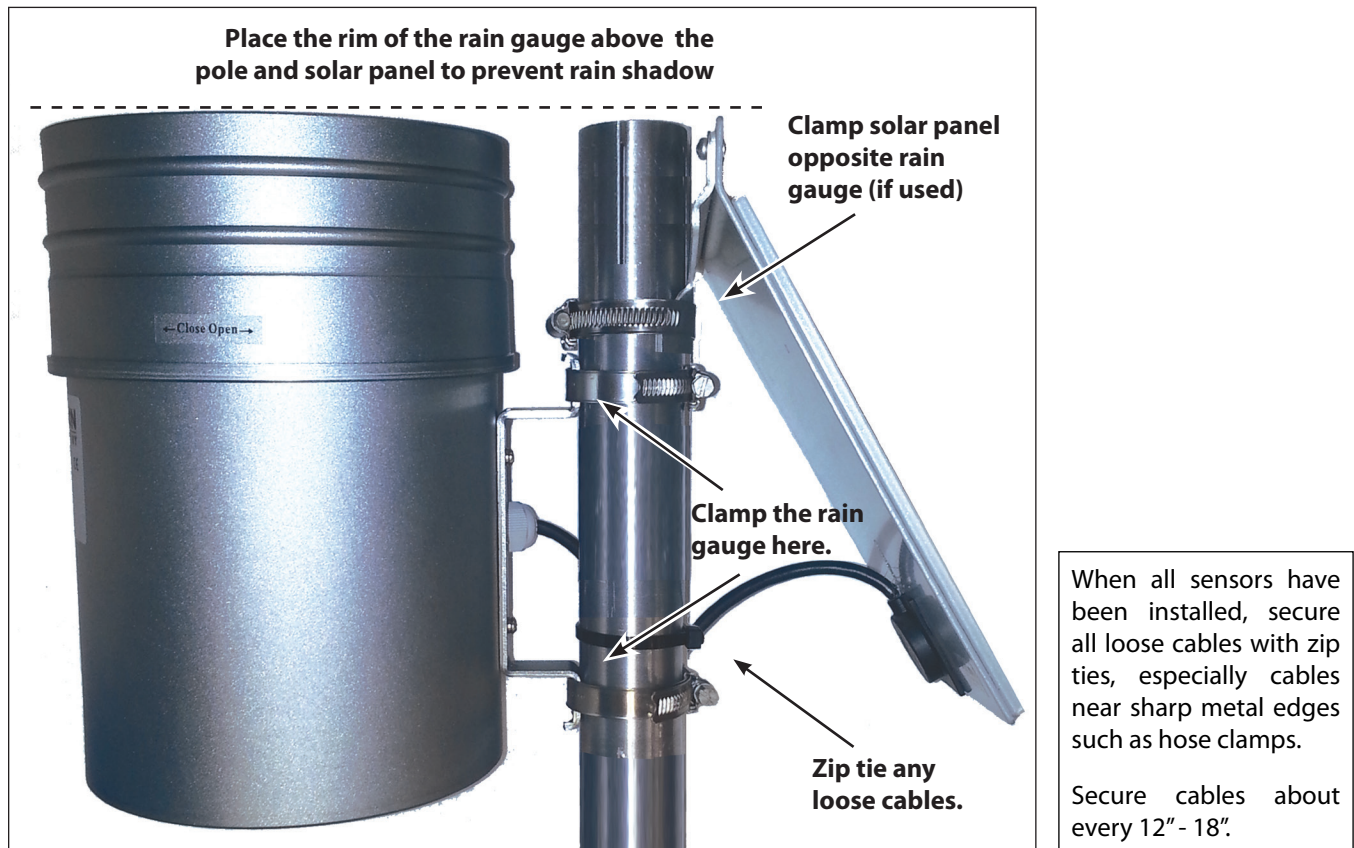

Figure 10. Solar panel and rain gauge attached to pole mount

## 4: Installing a pressure sensor

If you want to install a pressure sensor that can transmit measurement data to the FlowConnect unit, you will need the tools and materials listed at right.

This instruction is for a pipe that has an existing pressure gauge. If your pipe does not already have a location tapped and threaded, that will need to be done first. When completed, follow this instruction from step 2 below.

### TOOLS AND MATERIALS

**Note: Sensor parts are sold individually or as a bundle. The parts listed below are for sensor and cable bundles.**

PA-1 sensor and 10 m cable bundle (500.000.119) or

PA-1 sensor and 5 m cable bundle (500.000.120)

Cable for PA-1 pressure sensor

PA-1 pressure sensor 0-30 bar (200.733.162)

Crescent wrench or adjustable wrench

Channel locks (need to accommodate 3/4" pressure gauge)

Brass or steel wire brush



**WARNING!**  
Never remove a gauge while the line is under pressure!

- Remove the existing gauge from the pipe.
- Clean the interior pipe threads and remove any debris.
- Wrap the pipe threads on the pressure sensor with Teflon tape.
- Screw in the pressure sensor by hand until it is tight, then use the channel locks to fully tighten it.
- Connect the extension cable to the pressure sensor.
- Coil and secure any extra sensor cable with zip ties to prevent cable from being damaged or becoming a hazard.

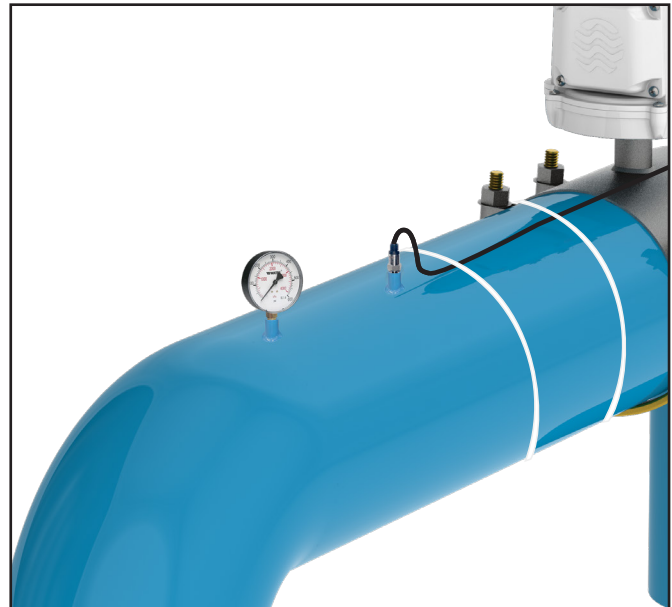
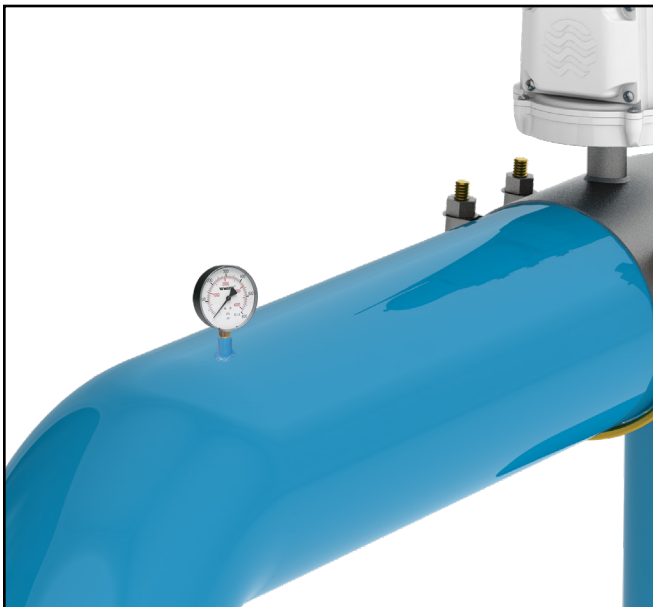

## 3 - Connecting Inputs and Outputs



### IMPORTANT!

Before purchasing any sensors, be sure to confirm that they are compatible with the FlowConnect system.

Figure 11 and Figure 12 below show possible methods of connecting inputs, outputs, and external power to the FlowConnect system. The examples in the figures show a FlowConnect with rechargeable batteries. If your system does not have rechargeable batteries, the connection plate will have only two connectors, Inputs and Outputs.

See the following page for discussion of the Power, Inputs, and Outputs connectors.

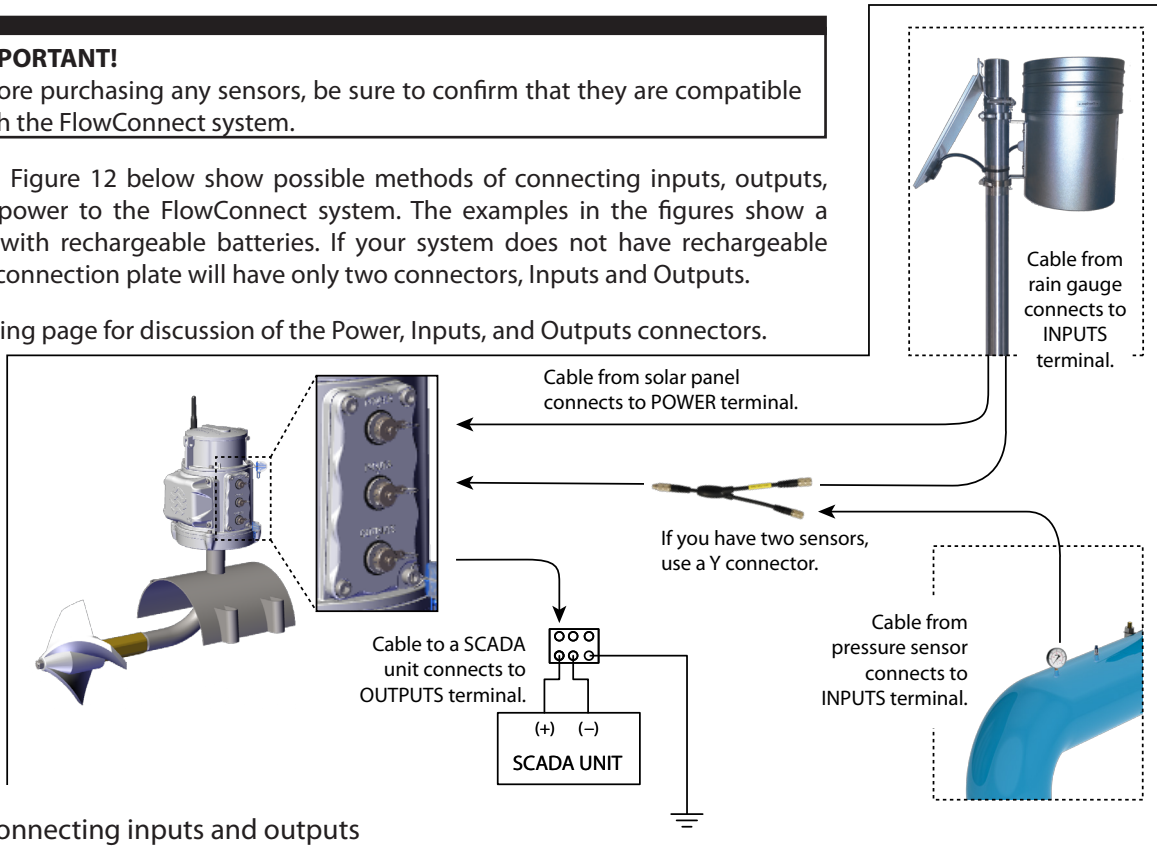
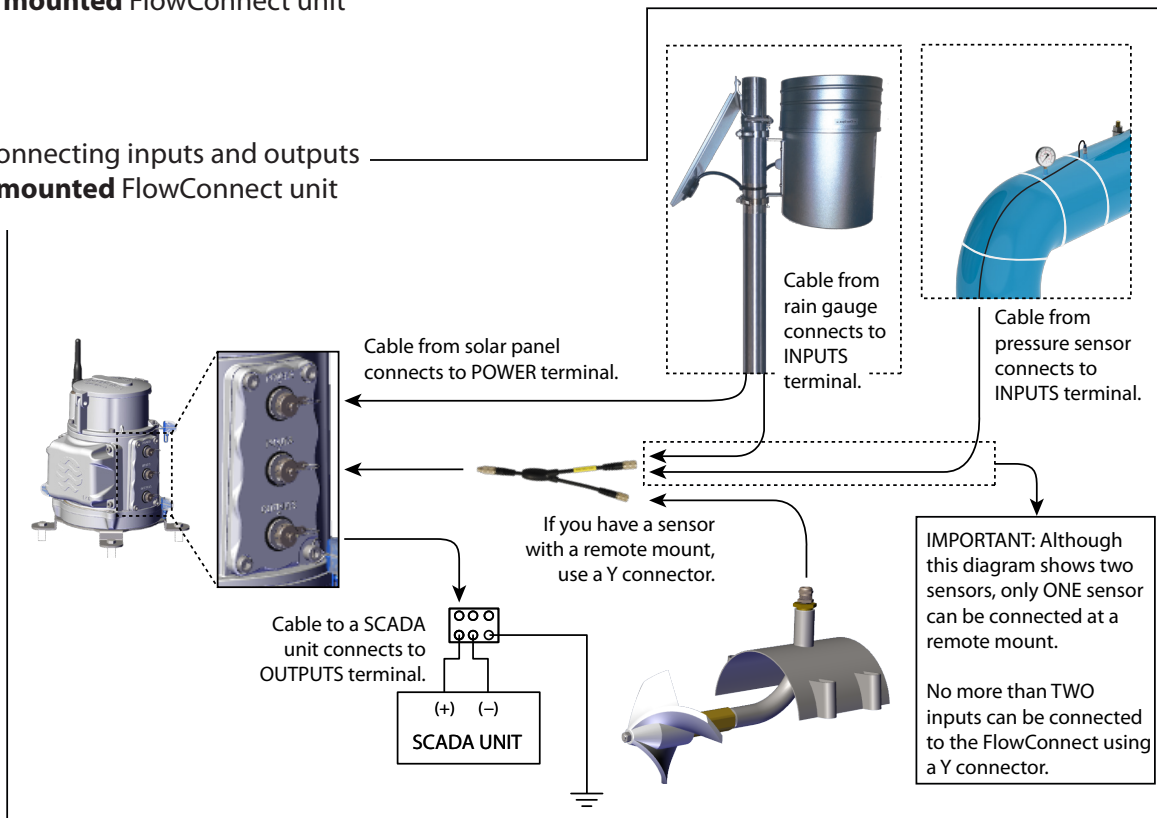

Figure 11. Connecting inputs and outputs to a **meter mounted** FlowConnect unit

Figure 12. Connecting inputs and outputs to a **remote mounted** FlowConnect unit



## 1: Power connector

For models with rechargeable batteries, a solar panel can be connected through the Power connector at the top of the connector plate.

## 2: Inputs connector

The FlowConnect unit supports up to two analog inputs through the Inputs connector. Inputs are most often sensors, such as a rain gauge or a pressure sensor. The Inputs connector will either be in the middle or at the bottom of the connector plate.

For simple configurations with just one sensor, plug the sensor directly into the Inputs port. To connect more than one sensor to the Inputs port, a Y-Cable (200.720.510) is needed. No more than two sensors can be connected at once, so only one Y-Cable is required.

## 3: Outputs connector

The Outputs connector is only available on FlowConnect models with a digital register. It provides 4-20mA and pulse output options. To enable the FlowConnect to send a 4-20mA or pulse output to another system, such as a SCADA system, an output cable (5M-025-OE) is required. If you choose to use this option, use the table below as a guide for wire colors:

| Output Cable Wire Color:                   | Grey       | Green      | Brown           | Yellow    | White         |
|--|------------|------------|-----------------|-----------|---------------|
| <b>Open Collector Pulse Only</b>           |            |            |                 | Pulse (-) | Pulse (+)     |
| <b>Optically Isolated Pulse and 4-20mA</b> | 4-20mA (+) | 4-20mA (-) |                 | Pulse (-) | Pulse (+)     |
| <b>Relay Pulse and 4-20mA</b>              | 4-20mA (+) | 4-20mA (-) | Normally Closed | Common    | Normally Open |

## 4 - Setting the New FlowCom Register

### Brief explanation of why this is necessary:

After a FlowCom unit has been replaced with a new FlowConnect unit, users may want to set the register with the total gallons amount from the previous register. The instructions below are a concise guide to programming and resetting the total gallons only.

See the FlowCom IOM for complete procedures and description of FlowCom programming and features.

### What this procedure will help you do:

As shown by the example at right (Figure 13), you will be able to change the total on the register that appears during normal operation.

This procedure will show you how to change the total from **0** to **12345**.

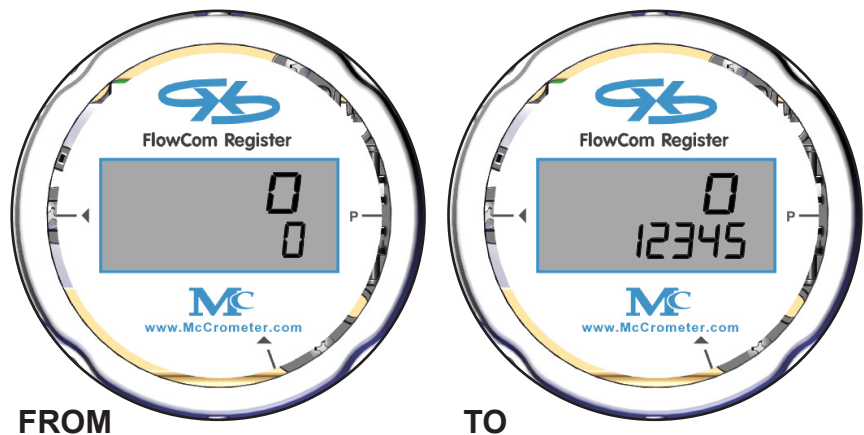

Figure 13. Example register totals



### WARNING!

It is very important that each step is followed carefully! If you do not feel confident programming the FlowCom register, we strongly recommend contacting a service technician.

While these instructions are streamlined for just the programming function required, if you find you made an error in and cannot back out of the menus, follow the "RECOVERY FROM ERROR" procedure.

### RECOVERY FROM ERROR

It is possible to make a wrong selection when programming the FlowCom register. If this happens, you can recover from the error by doing the following:

#### Cycle through the menu selections

- If you remember the original value, cycle through all of the values until you come to the selection you want.

#### Time out the programming mode

- If you can't find the value you want or find the menu you need, allow the programming mode to time itself out. This is done by making no selections or changes while the digital display is still flashing and waiting about 30 - 60 seconds.

There are three activation points located on the outside of the register that are used to access the configuration menu as shown in Figure 14:

- The **P** on the far right side is used for accessing and navigating through the programming menu.
- The ▲ arrow at the lower right side is used for incrementing flashing selections.
- The ◀ arrow at the far left side is used for moving to the next flashing selection.

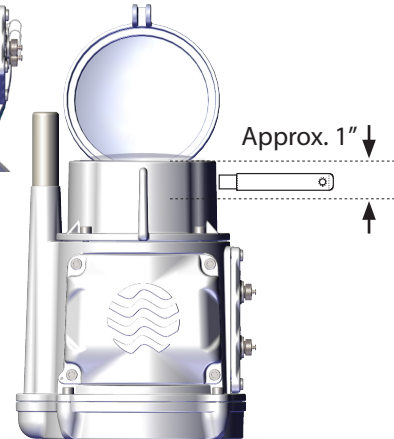
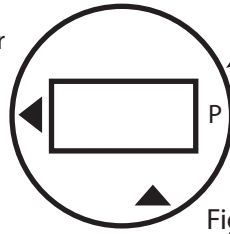

Figure 14. Magnetic wand activation points for configuration menu

## STEP 1: Enter PROGRAMMING MODE

- a. Hold the magnetic wand at the **P** on the right side of the register. After five seconds the register will display "Loc-codE" (Figure 15). The last digit will flash.

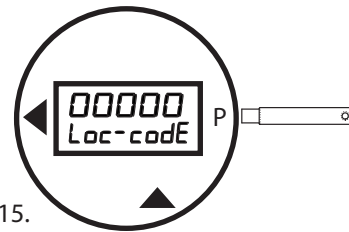

Figure 15.

- b. Pass the wand on the ◀ three times. The second digit from the left will flash (Figure 16).
- c. Pass the wand on the ▲ once. The display will increment from 0 to 1 (Figure 16).

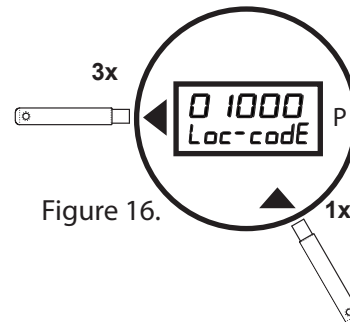

Figure 16.

**A lock code of 01000 is required to enter the configuration menu.**

- d. Pass the wand over the **P** to enter the lock code. The menu selection **rAtE-Un** will appear (Figure 17). This is the first item in the first menu level.

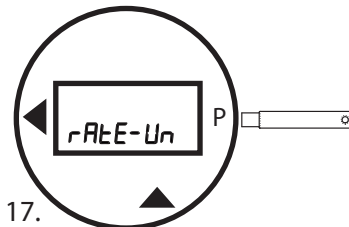

Figure 17.



**IMPORTANT:** Be careful not to change any settings as you cycle through the menu selections. If you accidentally make any changes, **stop immediately**, wait until the configuration mode times out, and start over.

## STEP 2: Cycle through the first menu level

The first level menu selection appear in the order shown in the table at right.

- Pass the wand over the **P** until you reach the **L1 -Go to** menu selection (Figure 18).  
If you pass it by, the menu selections will start again from the beginning.

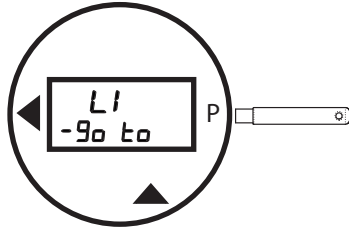

Figure 18.

- Pass the wand over the **▲** once. The selection will advance to **L2 -Go to** (Figure 19).

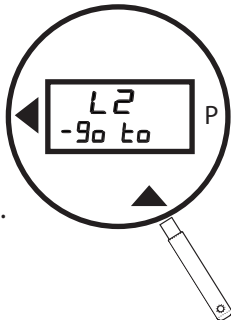

Figure 19.

- Pass the wand over the **P** once to advance to the second menu level. The selection **PAR-S** with the meter's serial number will appear (Figure 20). This is the first item in the second menu level.

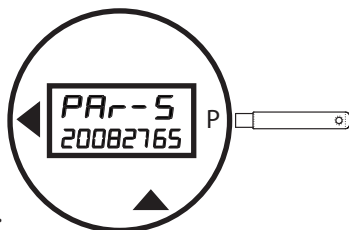

Figure 20.

| First Menu Level |                                |  |
|------------------|--------------------------------|--|
| Display          | Menu Title                     | Description                              |
| Loc-CodE         | Program Lock Out               | Enter w/ preset code                     |
| rAtE-Un          | Rate Unit/Time                 | Sets Unit/Time                           |
| rAtE-dP          | Rate Format                    | Sets Rate Decimal Place                  |
| tot-Un           | Totalizer Unit                 | Sets Unit                                |
| * tot-dP-E       | Totalizer Decimal Point Enable | Enables/Disables Totalizer Decimal Point |
| * tot-dP         | Totalizer Decimal Place        | Sets Decimal Place                       |
| * Tot-FACT       | Totalizer Multiplier           | Sets Multiplier                          |
| 20mA-Un          | 20mA Unit                      | Sets 20mA Unit                           |
| 20mA-dP          | 20mA DP                        | Sets 20mA Decimal Place                  |
| 20mA-FS          | 20mA FS                        | 20mA Full Scale                          |
| PLS-Un           | Pulse Unit                     | Sets Pulse Unit                          |
| PLS-dP           | Pulse Decimal Place            | Sets Pulse Decimal Place                 |
| PLS-Inc          | Pulse Increment                | Sets Pulse Value                         |
| CAL-Pct          | Calibration Percent            | Adjusts Meter Accuracy                   |
| L1 -Go to        | Go to Second Menu Level or Run |  |

\* These menu items are controlled by the tot-dP-E setting. Depending on its setting, either tot-dP or Tot-FACT will appear, but not both.

### STEP 3: Cycle through the second menu level

The second level menu selection appear in the order shown in the table at right.

- Pass the wand over the **P** until you reach the **tot-S** menu selection (Figure 21).

If you pass it by, the menu selections will start again from the beginning.

The number shown in the configuration menu will be 00000000 and not the total gallons the appears on the register during normal operation.

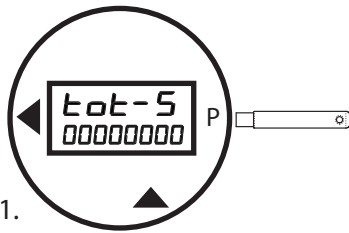

Figure 21.

### STEP 4: Set the total

- Pass the wand over the **◀** to move and activate each digit (Figure 22).

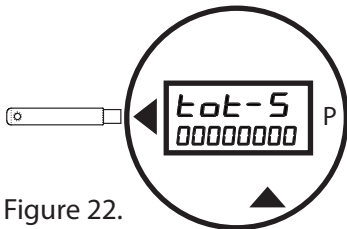

Figure 22.



Note: The flashing digits will activate from right to left.

- As each digit is activated, pass the wand over the **▲** to increment to the desired number (Figure 23).

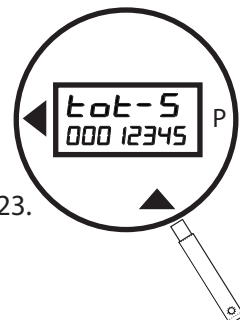
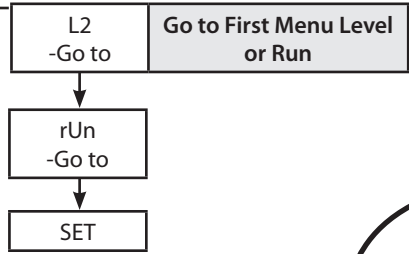

Figure 23.

| Second Menu Level |                        |  |
|-------------------|------------------------|--|
| Display           | Menu Title             | Description                                      |
| Par-S             | Parent Meter Serial #  | Sets Meter Serial No.                            |
| SErno             | Register Serial #      | Sets Register Serial No.                         |
| Set-CodE          | Set Lock Code          | Sets new Lock Code                               |
| GPr-dP            | GPR Decimal Place      | Sets GPR Decimal Place                           |
| GPr               | Gallons Per Revolution | Sets GRR Digits                                  |
| Smooth            | Smoothing              | Turns Smoothing on/off                           |
| 4mA-AdJ           | Trim 4mA               | Adjusts 4mA Zero                                 |
| 20mA-AdJ          | Trim 20mA              | Adjusts 20mA FS                                  |
| PLS-tYPE          | Pulse Type             | Sets Pulse Type                                  |
| PLSwidth          | Pulse Width            | Sets Pulse Width in ms                           |
| RESEttot          | Reset Total            | Zeroes Total                                     |
| * DIS-rSt         | Disable Reset Total    | Permanent Reset Disable<br><b>SEE NOTE BELOW</b> |
| tot-S             | Set Total              | Sets Total                                       |
| Au-InP            | Auxiliary Input        | Sets operation of input                          |
| cutoff            | Low Flow Cutoff        | Sets Min. Flowrate                               |
| PLS-Pr            | Pulses per Revolution  | Sensor Pulses per rev.                           |



## EXTREMELY IMPORTANT!



**Do not change the setting for the menu selection DIS-rSt!**

If this is set to "YES", you will not be able to change or reset the totalizer.

This will permanently change the menus and can only be corrected by returning the unit to the factory to have the firmware reflashed.

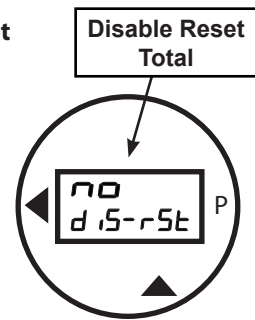

## STEP 5: Exit and save settings

Note: If you do not save your settings and allow the configuration mode to time out, your settings will be lost.

- a. Pass the wand over the **P** until you reach the **L2 - Go To** selection (Figure 24).

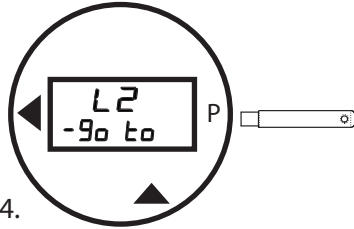

Figure 24.

- b. Pass the wand over ▲ to increment to the **rUn - Go** selection (Figure 25).

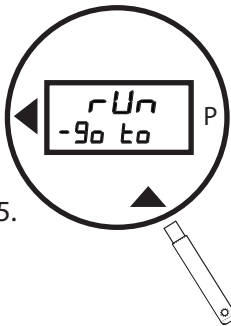

Figure 25.

- c. Pass the wand over **P**. This will end configuration mode and save your changes (Figure 26).

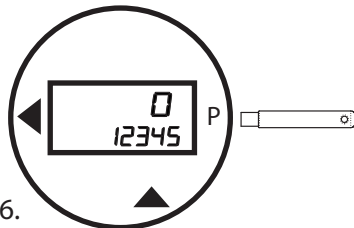

Figure 26.

NOTE: At the **L2 - Go To** selection, if you pass the wand over **P** to move to the second menu level, the selection **rUn - Go to** will appear. Then if you make a second pass over **P**, any changes made will be set.

