



FPI Mag 3000 Battery Powered Electromagnetic Flow Meter

Quick Start Installation Guide

30127-07 Rev. 1.0
13SEP2024



About This Quick Start Guide

This quick start guide is designed to provide installation instructions when the location of the sensor installation has been predetermined. If not, see the FPI Mag 3000 Installation, Operation and Maintenance manual (Lit. No. 30126-03).

About This Quick Start Guide 1

- 1. Verify Contents of Shipping Box 2
- 2. Verify Flow Meter Serial Numbers 2
- 3. Detach the Cable Quick Connects 2
- 4. Sensor Installation Location 3
- 5. Determine Sensor Clearance 3
- 6. Install Pipe Valve 3
- 7. Optional Step: Disassemble the Compression Seal - For large sensor installation 3
- 8. Connect Sensor on Pipe Valve 4
- 9. Optional Step: Reassemble the Sensor Compression Seal 4
- 10. Inserting the Sensor 5
- 10. Installing the Short Retaining Rods 6
- 11. Apply a Load to the Sensor 6
- 12. Sensor Grounding 6
- 13. Connect Sensor Outputs to Converter 7

WARNING!

 Incorrect installation or removal of FPI Mag meters can result in serious injury or death. Read the instructions and the safety warnings in the supplied manual carefully before installation. This guide is not intended as a substitute for reading the manual.



1. Verify Contents of Shipping Box

Upon receiving the meter, unpack the contents of the shipping box and verify that the items in listed below are included.

NOTE: If any of the above-listed items are not present, contact the factory before continuing with installation.

Contents of Shipping Box

Item	Quantity
FPI Mag Sensor	1
Long threaded retaining rods	2
Short threaded retaining rods	2
Converter	1
Calibration Certificate	1
FPI Mag Installation, Operation and Maintenance Manual	1
Converter Installation, Operation and Maintenance Manual	1
9/16" or 3/4" reversible ratchet wrenches	2
Hex nuts (3/8" or 1/2")	8
Locking cotter pins	4
Sensor and power cables with Quick-Connect	2
Brass ball valve & SS nipple	1
Protective caps for retaining rods	2

Tools Provided:

Two - 9/16" or 3/4" reversible ratchet wrenches. (Size is dependent on the size of the retaining rods supplied with the sensor and determined at the time of order.)

Tools recommended for installation

One - Pipe wrench capable of a 4" span

One - 7/16" wrench or crescent wrench

One- Sensor Insertion Tool (3/8" or 1/2")

NOTE: It is recommended that the Sensor Insertion Tool be used for easier and faster installation. See STEP 12.

2. Verify Flow Meter Serial Numbers

Verify the system serial numbers on both the sensor and converter match to ensure a properly calibrated system.

The meter serial number is located on the side of the sensor body on a silver label.

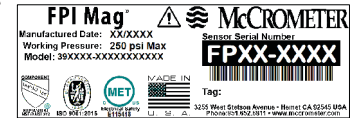

The tag on the side of the converter has the converter model number, the converter serial number and the meter serial number.



3. Detach the Cable Quick Connects

The meter cables are fitted with IP68 rated quick connect fittings at the sensor connection. Detach the cable prior to sensor installation.

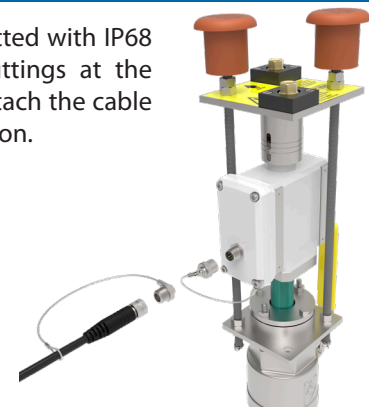

I IMPORTANT: When the cables are not attached to the sensor, connect the end caps to the sensor and cable connections to keep them free of dirt and corrosion. When the cables are attached to the sensor, connect the end caps together.

4. Sensor Installation Location

This Quick Start Guide is designed to provide installation instructions when the location of the sensor installation has been predetermined. If not, see the FPI Mag Installation, Operation and Maintenance manual (Lit. No. 30120-48).

5. Determine Sensor Clearance

The sensor will protrude from the pipe during installation and when installed requiring sufficient clearance from any obstruction.

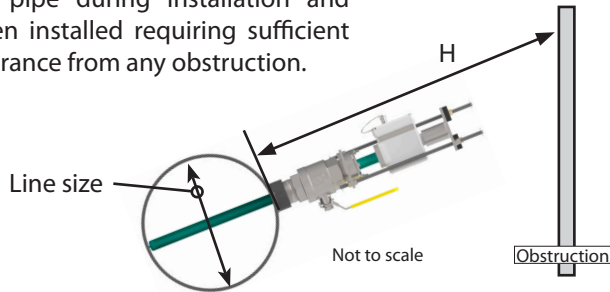

Line Size (Inches)	Distance H	22"	67"
4"	51"	30"	71.25"
6"	51"	36"	77.25"
8"	55"	42"	83.25"
10"	55"	48"	89.25"
12"	59"	54"	95.25"
14"	59"	60"	101.25"
16"	59"	66"	107.25"
18"	63"	72"	113.25"
20"	63"	78"-138"	Call Factory

Note: Actual clearance value varies by application.

6. Install Pipe Valve

WARNING! Pressurized pipes should only be hot tapped, cut, or drilled by qualified personnel using high quality saddles, valves and stainless steel nipples. If possible, depressurize the pipe before attempting any installation.

The sensor comes standard with a 2" stainless steel ball valve and a 2" x close stainless steel nipple. The 2" x close stainless steel nipple is to be used if the installation site has a female fitting, i.e., a welded coupling. If the installation site has a male fitting, i.e. a 2" nipple, then the supplied 2" x close stainless steel nipple is not required for the sensor installation.

Use pipe sealant or Teflon thread tape (not supplied with the sensor) when installing the valve onto the pipe.



I **IMPORTANT: The MINIMUM port inside diameter for all installation valves is 1-7/8" (48mm).**

7. Optional Step: Disassemble the Compression Seal - For large sensor installation

The sensor assembly can be installed onto the pipe valve as a whole unit. On larger pipe size installations this can be cumbersome or impractical. In such cases the compression seal assembly can be removed from the sensor for easier installation onto the pipe valve. Once the compression seal assembly is installed onto the pipe valve, then the sensor can be re-installed into the compression seal assembly.

NOTE: if this step is skipped, proceed to Step 8: "Sensor Installation Onto Pipe Valve".

- Loosen, but do not remove, the bolts and nuts on the compression seal relieving the pressure on the compression seal assembly.
- On the compression seal assembly, remove the locking cotter pins from the bottom of the two retaining rods under the 3/8" or 1/2" nuts.
- Remove the 3/8" or 1/2" nuts from the retaining rods.
- Slide the sensor out of the compression seal. The retaining rods will also slide out of the compression seal assembly. Carefully set the sensor and attached hardware to the side.

At this point the compression seal assembly can be installed onto the valve.

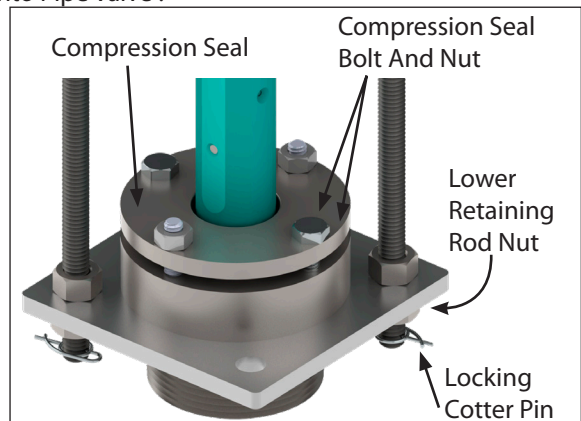

8. Connect Sensor on Pipe Valve

The sensor assembly uses a compression seal, which keeps the sensor watertight when the pipe is under pressure. Care must be taken when installing the sensor to avoid leaks.

1. Visually inspect all elements of the installation to ensure they are structurally sound and of high quality materials, including all welds, couplings and nipples.
2. Put a generous amount of on the compression seal threads. Teflon tape may also be used. NOTE: If pipe sealant gets on the sensor electrodes the velocity signal may be lost.
3. Place the compression seal threads over the pipe valve. Turn the entire sensor assembly clockwise to secure the assembly to the valve.

The seal is secure when a large amount of force is required to turn the assembly. Line up the arrow (on the top plate with the direction of the flow. The sides of the bottom plate should be parallel with the pipe.

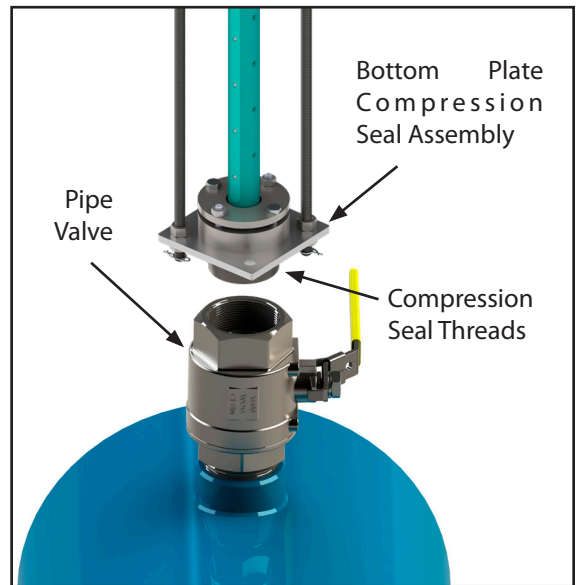

9. Optional Step: Reassemble the Sensor Compression Seal

NOTE: Use this step if you removed the compression seal assembly (Step 6) and installed it onto the pipe valve separate from the sensor. If you installed the sensor without disassembling it, proceed to the next step.

1. Apply water to the interior surface of the seal gland. This will act as a lubricant to facilitate the insertion of the sensor and ensure its proper axial loading.
2. Insert the sensor into the compression seal in the bottom plate while inserting the two retaining rods into their respective holes in the bottom plate and secure with 3/8" or 1/2" nuts above and below the bottom plate.
3. Ensure the two nuts above and below the compression seal assembly are sufficiently tightened to prevent the threaded rod from rotating.
4. Insert the locking cotter pins through small holes in the bottom of the retaining rods, just below the 3/8" or 1/2" nuts.

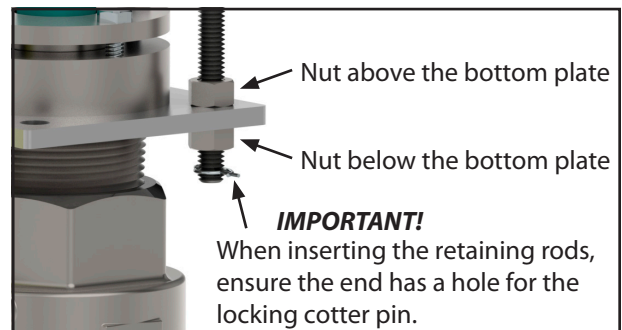

10. Inserting the Sensor

Follow the steps below to insert the sensor probe into the pipe.

1. If you disassembled and reassembled the compression seal, hand tighten the compression seal bolts and nuts. DO NOT FULLY TIGHTEN THE COMPRESSION SEAL BOLTS AND NUTS. If you did not disassemble the compression seal, proceed to step 2.
2. If the sensor is being installed under flowing conditions follow this step. If it is not, proceed to step 3.
Slightly open the valve to allow a little water into the compression seal assembly. Some water will leak from the compression seal. Lightly tighten the compression seal bolts and nuts as required to minimize the amount of water exiting the compression seal. A towel draped around the compression seal can reduce spray if necessary.
3. **Open the valve completely.** Failure to open the valve completely will cause the valve to scrape the sensor during insertions and may result in permanent damage to the sensor.

If you are using the sensor insertion tool:

4. Place the sensor insertion tool over the retaining rods and slide the retaining rods through the holes in the tool until it sits over the captive nuts.
5. Lock it into place with spring locks located on the bottom of the tool.
6. Using the provided wrench rotate the high gear shaft clockwise.
7. Continue to insert the sensor until the sensor probe tip reaches the far wall of the pipe and the load spring starts to compress.
8. Use the low gear shaft to apply pressure to the sensor when the sensor touches the other side of the pipe. Compression of the load spring is indicated by the movement of the set screw on the top plate.



If you are NOT using the sensor insertion tool:



IMPORTANT

If the captive nuts are not tightened simultaneously, the top plate will become crooked and cause the sensor to be inserted at an angle and may cause permanent damage to the sensor.

4. Rotate the two captive nuts on the top plate clockwise simultaneously with the provided 9/16" ratchet wrenches. This will insert the sensor probe into the pipe.
5. Continue inserting the sensor until the sensor probe tip reaches the far wall of the pipe and the load spring starts to compress. Compression of the load spring is indicated by the movement of the set screw on the top plate.

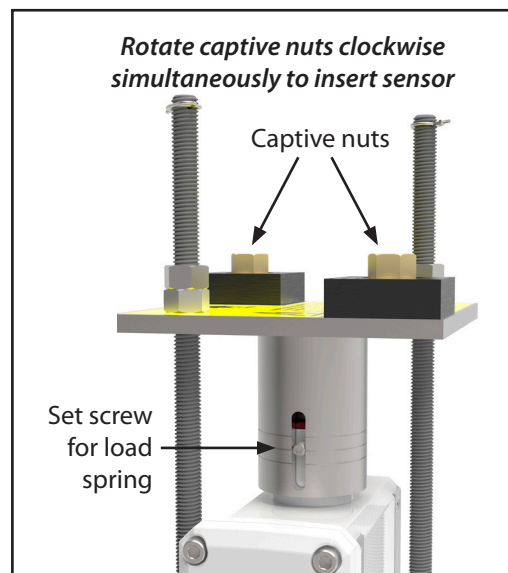

10. Installing the Short Retaining Rods

After the sensor has been inserted and the load adjusted, shorter retaining rods can be installed and the longer ones removed. This will make the sensor more compact.



IMPORTANT: The long retaining rods are matched to each sensor and are required for the removal of the sensor. It is important to safely store the long retaining rods and label them with the meter serial number.

1. Insert the two short retaining rods through the two holes in the top plate opposite the two captive nuts with the long retaining rods. Once the short retaining rods are passed through the top plate, thread one nut per rod onto the bottom of the rod about one inch.
2. Insert the two short rod ends through the corresponding holes on the compression seal bottom plate. Thread a nut onto the bottom of each short retaining rod.
3. Tighten the nuts above and below the compression seal bottom plate to secure the short retaining rods to the bottom plate.
4. Attach the locking cotter pins to each end of the short retaining rods.
5. Secure the short retaining rods to the top plate with one 3/8" or 1/2" nut per rod.
6. Remove the long retaining rods.
7. Check and adjust the "Sensor Load" as necessary. See Step 9.
8. Secure the 3/8" or 1/2" nuts on the top plate by running a second jam nut down and tightening it against the first nut.
9. Attach a locking cotter pin to the top ends of the short retaining rods.
10. Place the protective caps on the ends of the two retaining rods over the cotter pins.

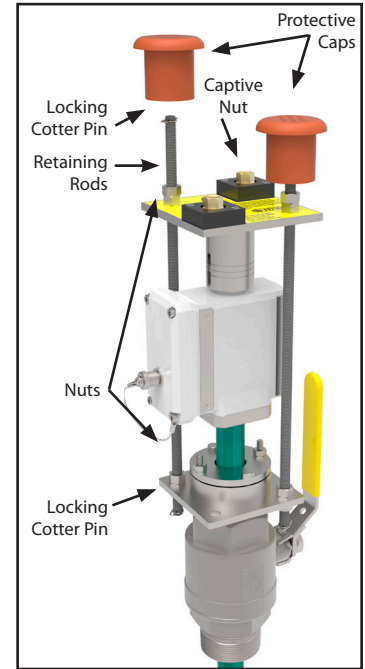

11. Apply a Load to the Sensor

FPI Mag meter is electrically continuous to a conductive (non PVC) pipe through the retaining rods. Additional grounding may be required to a dedicated earth ground via ring terminal and 10 AWG wire (not provided).

VFD's and chemical injection mechanisms may have adverse effects on the electromagnetic signal. Contact the factory for further information on grounding effects.

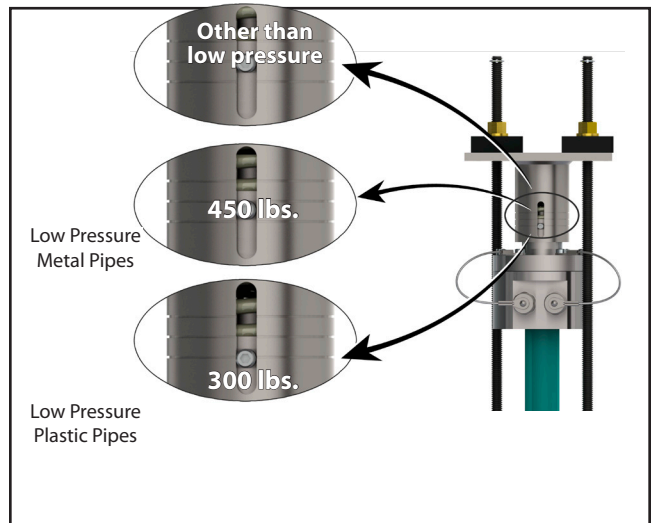

12. Sensor Grounding

FPI Mag meter is electrically continuous to a conductive (non PVC) pipe through the retaining rods. Additional grounding may be required to a dedicated earth ground via ring terminal and 10 AWG wire (not provided).

VFD's and chemical injection mechanisms may have adverse effects on the electromagnetic signal. Contact the factory for further information on grounding effects.

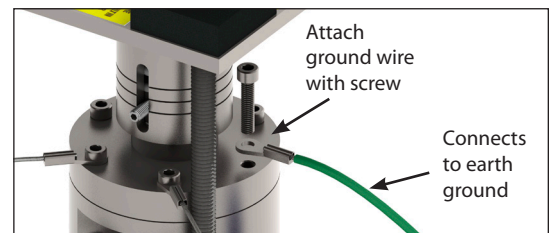

13. Connect Sensor Outputs to Converter

All electrical cables enter the converter through compression fittings located on the side of the converter. Ensure that all compression glands are properly tightened and all unused fittings are plugged so the case remains sealed.

All connections are made on the terminal board. To access the terminal board, loosen the four screws on the front of the converter and lift the converter open.

Port assignment

- 1 - Outputs
- 2 - Outputs
- 3 - Power
- 4 - Sensor
- 5 - Not used

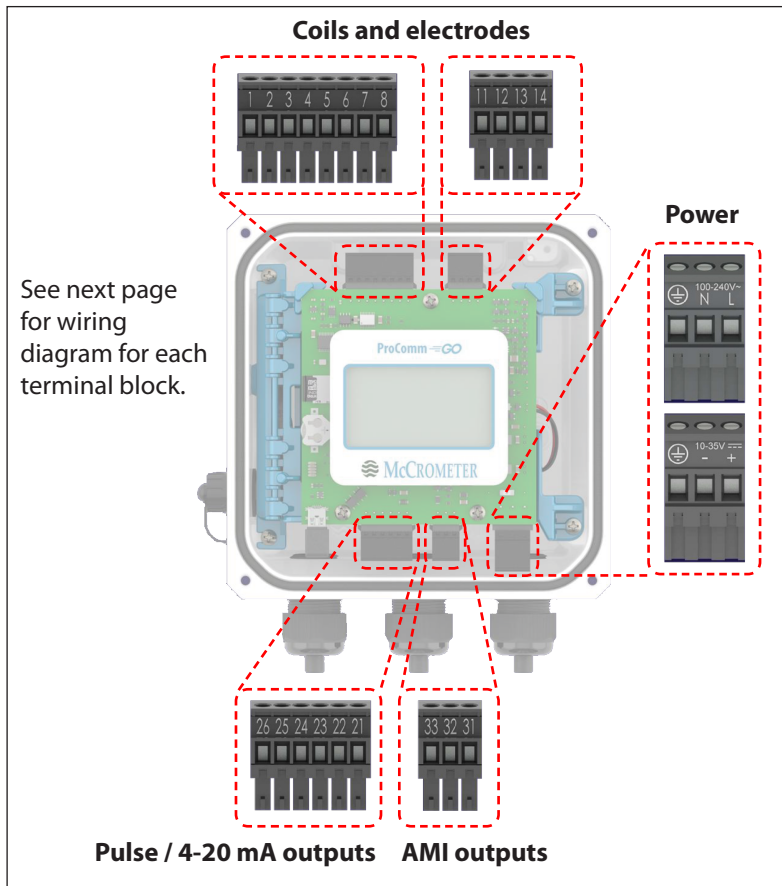
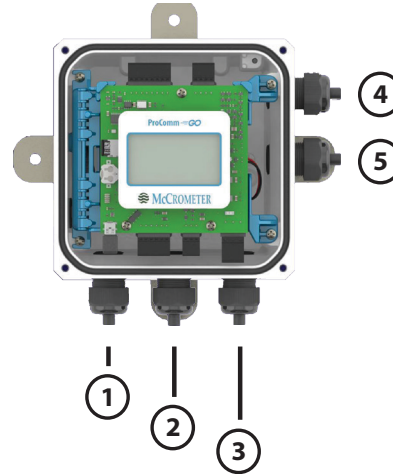

Terminal blocks

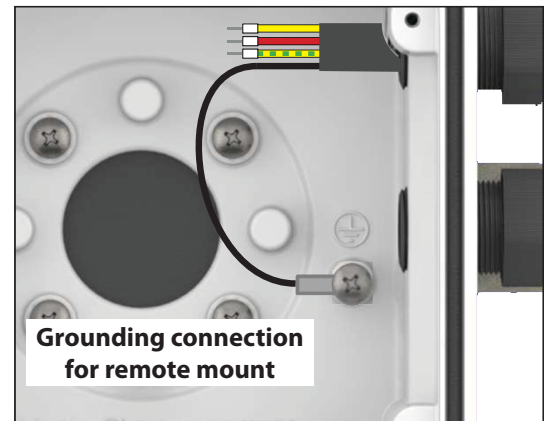

Grounding connection for remote mount

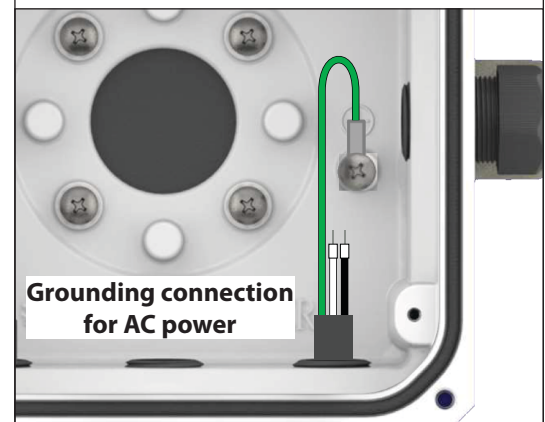

Grounding connection for AC power

Grounding lug

TERMINAL BLOCK ASSIGNMENTS

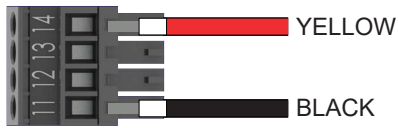

Coils Harness

Terminal	Port	Wire Color
14	4	Red
11	4	Black

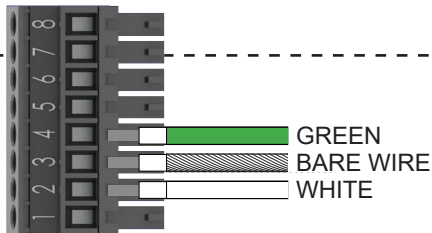

Electrodes Harness

Terminal	Port	Wire Color
4	5	Green
3	5	Bare wire
2	5	White

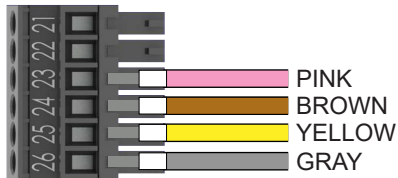

Pulse Output Harness

Terminal	Port	Wire Color
23	1	Pink
24	1	Brown
25	1	Yellow
26	1	Gray

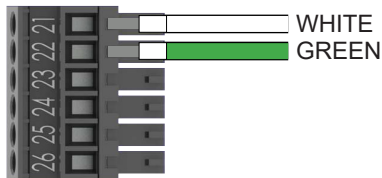

4-20 mA Output Harness

Terminal	Port	Wire Color
21	1	White
22	1	Green

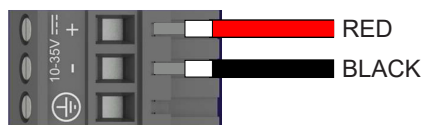

DC Power Harness

Terminal	Port	Wire Color
Negative	3	Black
Positive	3	Red

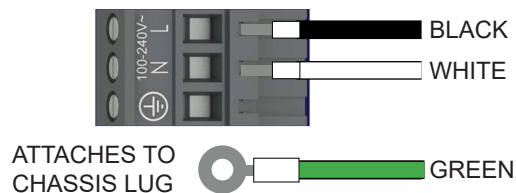

AC Power Harness

Terminal	Port	Wire Color
Ground	3	Green
Negative	3	White
Load	3	Black

To complete AC power connection, connect green grounding lug to chassis as shown on previous page.



McCrometer, Inc.
3255 West Stetson Avenue
Hemet, CA 92545 USA
Tel: 951-652-6811
800-220-2279
Fax: 951-652-3078
customerservice@mccrometer.com
www.mccrometer.com